



Premier Baldwin P-47 Steam Locomotive

OPERATOR'S MANUAL



Compatibility

This engine is available in 2-rail and 3-rail versions and will operate on any traditional O-42 Gauge track system (3-rail) or any 40" radius 2-rail track system. It is also compatible with most standard AC and DC transformers. (See page 23 for a complete list of compatible transformers and wiring instructions.)



Passenger Station Announcement



PLEASE READ BEFORE USE AND SAVE

Table of Contents

Configuring Locomotive for 2-Rail or 3-Rail Operation.....	3
Installing/Removing Pickup Rollers.....	3
Configuring for 2-rail or 3-rail power input.....	3
Ensuring Proper Power to Track Polarity.....	4
Changing Track Polarity Inside Locomotive.....	4
Locomotive Coupler Options.....	5
Set Up Checklist.....	6
Lubrication.....	6
Priming The Smoke Unit.....	6
Placing the Engine on the Track	7
Checking The Battery.....	7
Basic Operation.....	8
Activating Features.....	8
Proto-Sound 2.0 Operating Instructions.....	9
Activating Proto-Sound 2.0 Conventional Mode Features.....	9
Passenger Station Announcements (PSA).....	10
Proto-Coupler® Operation.....	11
Speed Control.....	12
Locking Locomotive Into A Direction.....	12
Reset To Factory Default.....	13
Automatic Sound Effects.....	13
Maintenance.....	14
Lubricating and Greasing Instructions.....	14
Cleaning The Wheels, Tires and Track.....	15
Traction Tire Replacement Instructions.....	15
Headlight Replacement Instructions.....	17
Self Charging Battery Back-Up.....	18
ProtoSmoke® Unit Operation.....	19
Troubleshooting Proto-Sound® 2.0 Problems.....	21
Transformer Compatibility and Wiring Chart.....	23
Additional Features Accessible Of DCS Remote Control System...	24
Service & Warranty Information.....	25
Limited One-Year Warranty.....	25

CAUTION: ELECTRICALLY OPERATED PRODUCT:

Not recommended for children under 10 years of age. M.T.H. recommends adult supervision with children ages 10 - 16. As with all electric products, precautions should be observed during handling and use to reduce the risk of electric shock.

WARNING: When using electrical products, basic safety precautions should be observed, including the following:

Read this manual thoroughly before using this device.

- M.T.H. recommends that all users and persons supervising use examine the hobby transformer and other electronic equipment periodically for conditions that may result in the risk of fire, electric shock, or injury to persons, such as damage to the primary cord, plug blades, housing, output jacks or other parts. In the event such conditions exist, the train set should not be used until properly repaired.
- Do not operate your layout unattended. Obstructed accessories or stalled trains may overheat, resulting in damage to your layout.
- This train set is intended for indoor use. Do not use if water is present. Serious injury or fatality may result.
- Do not operate the hobby transformer with damaged cord, plug, switches, buttons or case.

Configuring Locomotive for 2-Rail or 3-Rail Operation

Installing/Removing 3-Rail Pickup Rollers

Both 2-Rail and 3-Rail versions of this locomotive can be configured to operate on either 2-rail or 3-rail track by removing or adding the center rail pickups. 3-rail track operation requires the pickups, 2-rail track operation does not. The pickups are factory installed on 3-rail versions and packaged separately in the locomotive box for 2-rail versions. Each pickup roller installs with a single phillips screw seen in Figure 1.



Figure 1: 3-Rail Pickups installed with a single Phillips Screw

Configuring for 2-Rail or 3-Rail Power Input

Once you have configured the engine for 2-rail or 3-rail operation, you must manually set the power input switch located under the tender, to 2-rail or 3-rail operation, as seen in figure 2.

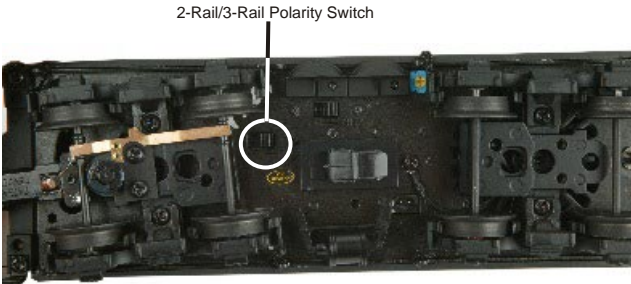

Figure 2: Selecting 2-rail or 3-rail power input setting

Ensuring Proper Power to Track Polarity

For 2-rail DCS operation, it is important that the polarity from the transformer to the engine is properly configured. Correct polarity can be accomplished by ensuring that the wiring from the TIU to the track and orientation of the locomotive when sitting on the track follows the illustration in Figure 3.

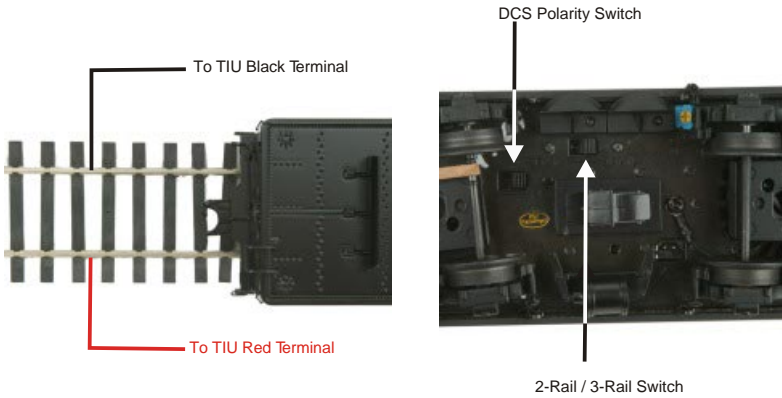

Figure 3: Proper 2-Rail polarity wiring and locomotive orientation

Changing Track Polarity Inside the Locomotive

Failing to properly configure the polarity will result in the locomotive starting in reverse instead of forward or not receiving the DCS signal. Should this occur, it is not necessary to swap the wires from the transformer to the track or reverse the locomotive's orientation on the track itself. Instead, simply slide the polarity switch located in the second top hatch on the tender as seen in Figure 4.

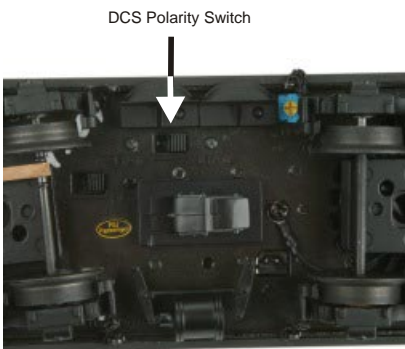

Figure 4: Changing the polarity with the locomotive polarity switch

Changing Track Polarity Inside the Locomotive

All 2-rail locomotive models do not come with a rear coupler since many 2-rail enthusiasts may utilize different coupler types on their 2-rail locomotives and cars. Each tender has pre-drilled holes for use when installing a Kadee® scale coupler as seen in Figure 5. Follow the individual coupler installation instructions when installing another manufacturer's coupler system.

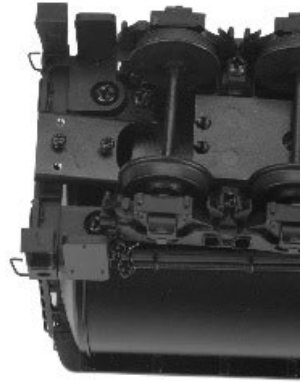

Figure 5: Pre-drilled Kadee® Coupler mounting holes

Owners of 2-rail models who intend to run this locomotive on a 3-rail layout will find a M.T.H. Proto-coupler assembly for this model packed separately in the styrofoam box so that they may enjoy remote uncoupling action anywhere on a layout. Simply remove the Kadee® Coupler Bracket. Attach the Proto-coupler assembly to the rear truck with the supplied parts and connect the Proto-coupler wire inside the tender.

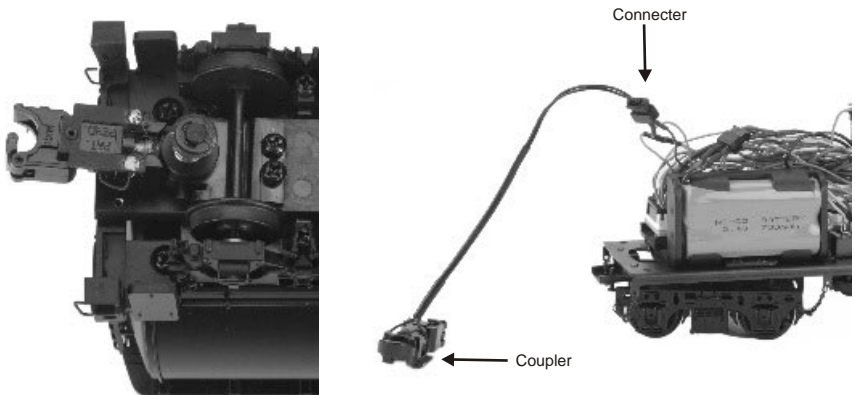

Figure 6: 3-Rail Proto-Coupler and Connection

Set Up Checklist

- Lubricate the locomotive
- Prime the smoke unit
- Check to see whether the battery needs to be charged for full sound effects
- Apply power to run as described in the Basic Operating Section of this manual

Lubrication

You should lubricate the engine to prevent it from squeaking. Use light household oil and follow the lubrication points marked “L” in Fig. 1. Do not over-oil. Use only a drop or two on each pivot point.

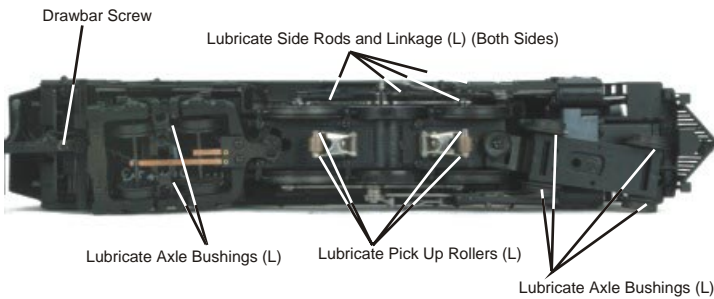

Figure 7: Lubrication Points on the Locomotive

Priming the Smoke Unit

When preparing to run this engine, add 15-20 drops of smoke fluid through the smokestack. We recommend M.T.H. ProtoSmoke, Seuthe, LGB, or LVTS fluids. Do not overfill the unit or the fluid may leak out and coat the interior engine components.

If you choose not to add the fluid (or have already added the fluid but choose to run smoke-free), turn off the smoke unit switch located under the tender (see Fig. 8). **Failure either to add fluid to the unit or to turn it off may damage the smoke unit heating element and/or wicking material.**

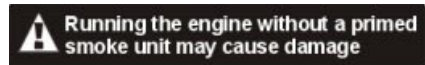

Figure 8: Smoke Unit Switch Location (Inside Tender Hatches)

Placing The Engine On The Track

Place the engine on the track, then insert the reverse unit plug that extends out of the tender into the receptacle at the back of the boiler cab (Figure 9).

WARNING: DO NOT CONNECT THIS ENGINE TO A TENDER FROM ANOTHER ENGINE; IT MAY CAUSE SERIOUS DAMAGE. Look at the bottom of the engine and tender where each will have a color-coded stamp. If they match you may connect those two pieces; if not, don't.

Connect the draw bar between the engine and tender. The draw bar hole located farthest from the tender is for applications such as display. The second hole is for normal operation on the track.

At this point, you are ready to begin running your engine.



Plug Tender Plug into
Boiler Socket at back of cab.

Figure 9

Checking the Battery

You may find, if your locomotive was built several months before you set it up, that the rechargeable battery has run down and needs to be charged before operating. If you notice that the sounds are garbled, test and charge the engine as described in the "Self-Charging Battery Back-Up" on page 18.

Basic Operation

The Throttle knob controls how fast your train will travel.

Turn the throttle knob up 1/2-way, until the engine and caboose lights shine bright.

Put the engine into motion by pressing the Direction button on your transformer once. (hold it for approximately 1 second)

If the engine does not begin to move as soon as you firmly press the Direction button, you may not have sent enough voltage to the track to make the train move. Turn the throttle up a bit higher until the train begins to move.

Activating Features

Throttle - To increase or decrease track voltage, and therefore train speed, turn the throttle control knob. Turning clockwise will increase voltage and speed, while turning counterclockwise will decrease voltage and speed. The engine will maintain the speed you set after you release the throttle until you turn it again to change the voltage and speed.

Bell - To sound the bell, in an engine equipped with a bell firmly press and release the Bell button. To turn the bell off, press and release the Bell button again. The bell will continue to ring from the time you turn it on until you press and release the button again to turn it off.

Horn/Whistle - To sound the whistle, firmly press the Horn/Whistle button. The whistle will sound for as long as you continue to depress the button. It will stop when you release the button.

Direction - Your train is programmed to start in neutral. The train will always cycle neutral-forward-neutral-reverse with each press and release of the direction button. The engine is programmed to restart in neutral each time the track voltage is turned off for 25 seconds or more.

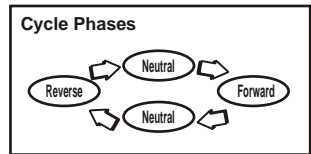

Manual Volume Control

To adjust the volume of all sounds made by this engine, turn the master volume control knob, located under the water hatch on the tender deck, clockwise to increase the volume and counter-clockwise to decrease the volume.

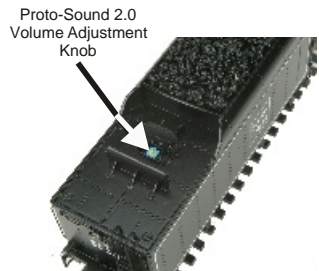

Figure 10: Manually Adjusting the Volume

Proto-Sound 2.0 Operating Instructions

This manual contains the operating instructions for Proto-Sound 2.0 in conventional mode only. Instructions for accessing DCS command mode features accompany the DCS Remote Control System equipment.

Activating Proto-Sound 2.0 Conventional Mode Features

Proto-Sound 2.0 features are activated by sequences of Bell and Horn button pushes described below. Please read the full descriptions of each feature before using it. To use these buttons to activate features rather than to blow the horn or ring the bell, you should tap the buttons very quickly with a ½-second pause between button presses. You may need to practice your timing to make this work smoothly.

Timing Chart				
Press Horn Short & Firm	½ Sec. Pause	Press Bell Short & Firm	½ Sec. Pause	Press Bell Short & Firm
Total Time Lapse: 1 ½ Seconds				

Feature to Be Activated	Button Code:
Passenger Station Announcements	1 Bell, 2 Horns
Fire the Rear Coupler	1 Bell, 3 Horns
Fire the Front Coupler	1 Bell, 4 Horns
Speed Control On/Off	1 Horn, 2 Bells (from Neutral only)
Lock into a Direction	1 Horn, 3 Bells
Reset to Factory Defaults	1 Horn, 5 Bells (from Neutral only)

Passenger Station Announcements (PSA)

Your engine is equipped with a sound package of passenger station announcements that you can play when you pull into a station. Each sequence described below will play as long as it is left on, randomly generating sounds, but be sure to allow approximately 30 seconds between the button pushes described below to allow the PSA sufficient time to run through each sequence.

- To cue the sound system to play the PSA, quickly but firmly tap the Bell button once followed by 2 quick taps of the Horn button while the engine is moving. Tap the buttons quickly but allow approximately ½ second between each press.

- Press the Direction button once to stop the engine. This will trigger the first sequence of PSA. The reverse unit is temporarily disabled so that the train will not move as you use the Direction button to trigger the sounds, and Proto-Sound 2.0 has disabled operator control over the Horn and Bell buttons until the full PSA sequence is complete.

- After waiting about 30 seconds for that sequence to run, press the Direction button again to trigger the second sequence of PSA.

- After about 30 seconds, press the Direction button again to trigger the third PSA sequence.

- Again, after allowing about 30 seconds for that sequence to run, press the Direction button one more time to trigger the fourth and final PSA sequence. The PSA will continue, and within a few seconds, the engine and bell will start and move out on its own at the current throttle setting, in the same direction it was traveling when you began the sequence. Once the bell turns off, the operator regains control of the transformer's bell and Horn buttons and can ring the bell or blow the Horn as usual.

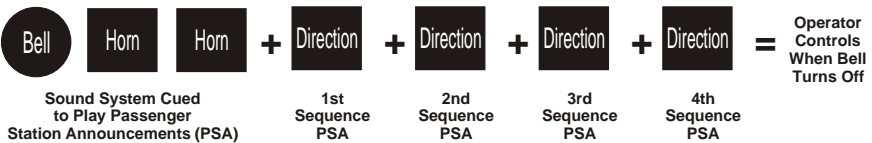

Tips on Using PSA

- You can terminate PSA at any time by turning off power to the track for 15 seconds.
- You do not have to be in Forward to use PSA. At the conclusion of the full sequence, the train will pull away from the station in whatever direction you were going when you activated the feature.
- You can use PSA even if you are double-heading with another engine. If the second engine is not equipped with Proto-Sound 2.0, you must remember not to leave the throttle at a high voltage level once you have stopped the engine to run the PSA. Otherwise, the engine without PSA will begin vibrating on the track as its motors strain to move the train, since they cannot be automatically disabled during the PSA cycle (or if an original Proto-Sound engine, PSA are triggered differently and that engine's motor-disable feature will not be active when you run PSA in Proto-Sound 2.0).
- PSA can be triggered from Neutral. It will operate the same as if triggered while in motion except that, at the conclusion of the PSA, the engine will depart in the next direction of travel, as opposed to the direction it was traveling before entering Neutral.

Proto-Coupler® Operation

This locomotive is equipped with one or more coil-wound Proto-Couplers for remote uncoupling action. Because Proto-Couplers are controlled through the Proto-Sound 2.0 microprocessor, they do not require an uncoupling track section or modification to your layout to function. You can fire a coupler from neutral or while in motion. Use the code shown below (and in the chart on p. 9) to fire the coupler(s).

Rear Coupler:

To fire the rear coupler, quickly tap the Bell button once followed by three quick taps of the Horn button, allowing approximately ½ second to lapse between each quick button press. The sound of the liftbar and air line depletion will play, and the knuckle will be released.



Front Coupler:

To fire the front coupler (if your engine has one), quickly tap the Bell button once followed by four quick taps of the Horn button, allowing approximately ½ second to lapse between each quick button press. The sound of the liftbar and air line depletion will play, and the knuckle will be released.



Speed Control

M.T.H. engines equipped with Proto-Sound 2.0 have speed control capabilities that allow the engine to maintain a constant speed up and down grades and around curves, much like an automobile cruise control. You can add or drop cars on the run, and the engine will maintain the speed you set.

While the engine is programmed to start with the speed control feature activated, you can opt to turn it off. This means the engine's speed will fall as it labors up a hill and increase as it travels downward. It is also affected by the addition or releasing of cars while on the run. Because the engine will run more slowly at a given throttle voltage when speed control is on than when it is off, you should adjust the throttle to a lower power level for operation with speed control off to avoid high-speed derailments. When speed control is off, the volume will drop to allow for better low voltage operation.

To turn speed control on and off, put the engine in neutral, then quickly tap the transformer's Horn button one time then quickly tap the Bell button two times, allowing approximately ½ second to lapse between each quick button press. Two horn blasts will indicate that the engine has made the change. Repeat the 1 horn, 2 bells code to return it to the other condition. You will want to do this during the initial neutral upon start-up if you ever couple this engine to another engine that is not equipped with speed control to avoid damaging the motors in either engine. Each time you shut down the engine completely, it will automatically turn speed control on.



Place
Engine into
Neutral



Speed Control
Two Horn Blasts
= (indicates change is made)
Repeat to Return
to Normal Condition

Locking Locomotive Into A Direction

You can lock your engine into a direction (forward, neutral, or reverse) so that it will not change directions. To do this, put the engine into the direction you want (or into neutral to lock it into neutral), run it at a very slow crawl (as slowly as it will move without halting), and quickly but firmly tap the Horn button once followed by three quick taps of the Bell button, allowing approximately ½ second to lapse between each quick button press. Two horn blasts will indicate that the engine has made the change. The engine will not change direction (including going into neutral) until you repeat the 1 horn, 3 bells code to return the engine to its normal condition, even if the engine is kept without power for extended periods of time.

Place
Engine into
Desired
Direction



Direction Lock
Two Horn Blasts
= (indicates change is made)
Repeat to Return
to Normal Condition

Reset to Factory Default

To override the settings you currently have assigned to the engine and reset it to its factory defaults, while in Neutral tap the Horn button quickly once, followed by five quick taps of the Bell button, allowing approximately ½ second to lapse between each quick button press. Two horn blasts will indicate that the engine has made the change.



Automatic Sound Effects

Certain Proto-Sound 2.0 sound effects automatically play in programmed conventional mode conditions:

- Squealing Brakes play any time the engine's speed decreases rapidly.
- Cab Chatter plays at random intervals when the engine idles in neutral.
- Engine Start-up and Shut-down sounds play when the engine is initially powered on or is powered off for five seconds or more.

Maintenance

Lubricating and Greasing Instructions

The engine should be well oiled and greased in order to run properly. You should regularly lubricate all side rods, linkage components and pickup rollers to prevent them from squeaking. Use light household oil and follow the lubrication points marked “L” in Fig. 7. Do not over-oil. Use only a drop or two on each pivot point.

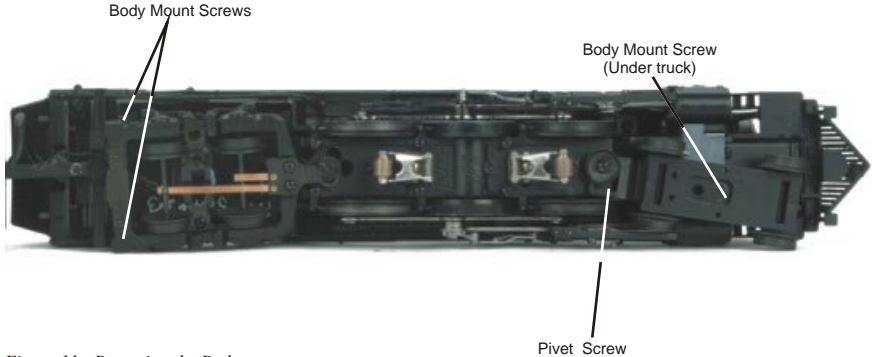

Figure 11: Removing the Body

The locomotive's internal gearing was greased at the factory and should not need additional grease until after 50 hours of operation or one year, whichever comes first. To access the gear box and axles, do the following:

1. Turn the engine upside down.
2. Remove the Phillips screws (marked “GREASE”). One is located directly under the front pickup roller. The other is located in the center of the drive wheels.
3. Use a grease tube dispenser to put a small amount (approx. 1-2 ml.) of lithium-based grease into the gearbox and axles.
4. Replace the screws.

You should also grease the leading and trailing locomotive truck tongues to enhance their ability to slide on the chassis. Follow the grease points shown on Fig. 12.

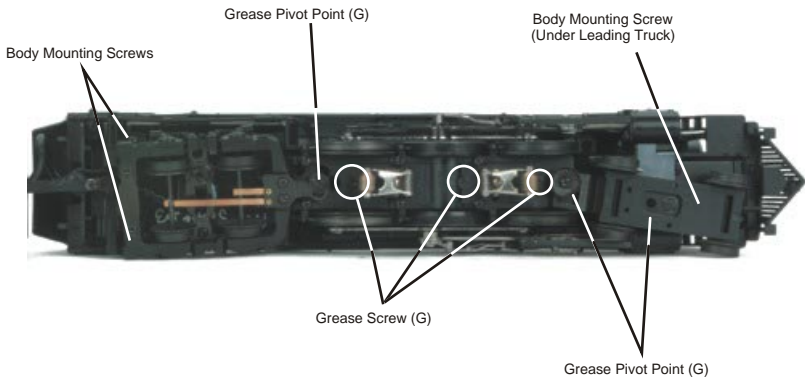

Figure 12: Lubricating The Grease Points

Cleaning the Wheels, Tires and Track

Periodically check the locomotive wheels and pickups for dirt and buildup, which can cause poor electrical contact and traction as well as prematurely wear out the neoprene traction tires. Wheels and tires can be cleaned using denatured (not rubbing) alcohol applied with a cotton swab.



Tire Traction Replacement Instructions (3-Rail Version Only)

Your 3-rail locomotive is equipped with two neoprene rubber traction tires on the rear set of flanged drivers. While these tires are extremely durable, you may need to replace them at some point.

1. Remove the side rods from the wheels in order to slip the new tire over the grooved drive wheel. Make sure to note the position of all rods before removing.
2. Make sure the old tire has been completely removed from the groove in the drive wheel, using a razor blade or small flathead screwdriver to pry away any remains.
3. Slip the new tire onto the wheel. You may find it useful to use two small flathead screwdrivers to stretch the tire over the wheel.
4. If you twist the tire while stretching it over the wheel, you will need to remove and reinstall the tire. Otherwise your engine will wobble while operating.

5. Make sure the tire is fully seated inside the groove. Use a razor blade to trim away any excess tire that doesn't seat itself inside the groove properly.
6. Reinstall the side rods in the same positions as noted. Failure to align rods may cause binding or damage to the drive system.

One set of replacement tires is packaged with your model. Additional sets are available directly from the M.T.H. Parts Department (phone: 410-381-2580; e-mail: parts@mth-railking.com; mail: 7020 Columbia Gateway Drive, Columbia MD 21046-1532).

Headlight Replacement Instructions

The locomotive's lights are controlled by a constant voltage circuit in the engine. They are easy to remove and replace when they burn out. See the diagrams and directions below for instructions on accessing and replacing the light bulbs in this locomotive.

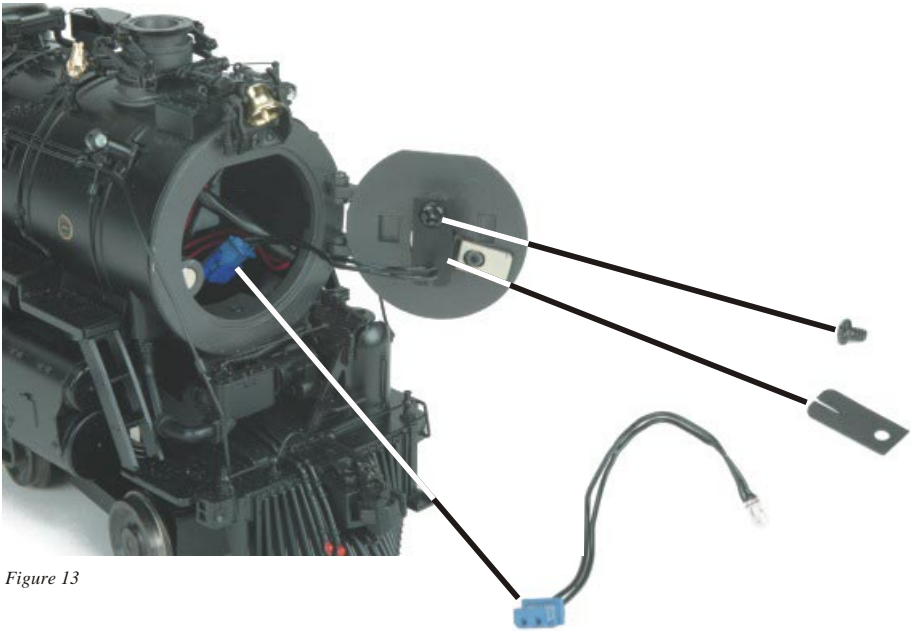

Figure 13

Headlight:

The locomotive's headlight is controlled by a constant voltage circuit in the engine. The headlight is easy to remove and replace when it burns out. The bulb has a quick disconnect plug that attaches the bulb harness to a light circuit. Replacement bulbs are available directly from the M.T.H. Parts Department.

1. Open smokebox door
2. Pull wires from inside boiler
3. Unplug connector
4. Remove bulb from headlight shell
5. Install new bulb in reverse order

Self Charging Battery Backup

The special NiCad 2.4v self-charging battery recharges continuously during train operation and should last for up to five years. The battery is a dry battery that should not leak or cause any damage to your engine. Depending upon when your engine was built, it may need to be charged right out of the box. If engine sounds seem distorted or garbled at low voltages or become silent when power from the transformer is turned off, test the battery to determine whether it should be recharged or replaced.

Test: Put the engine in neutral and leave the track voltage at 10-12 volts (high enough for the lights to shine brightly) for 15 minutes.

Recharge: If the sounds are improved at the end of the 15-minute test charge, the battery charge has run down and can be recharged. There are a number of ways you can do this:

- Leave the engine in neutral with track voltage at 10-12 volts for 6-7 hours so the battery can fully recharge (if your engine has a smoke unit, be sure it is turned off).

- Use M.T.H.'s battery recharger (sold separately) that plugs into a wall outlet and a special port under the engine to recharge the battery overnight without leaving it on the track.

Replace: If the sounds are not improved at the end of the 15-minute test charge, it is time to replace the battery. Available through M.T.H. Parts.



Figure 14

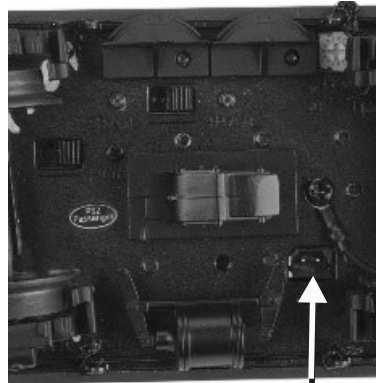

Figure 15

Battery Port

ProtoSmoke® Unit Operation

This Premier steam locomotive contains a self-powered smoke unit that outputs smoke through the smokestack on the roof of the engine. The smoke unit is essentially a small heating element and wick that soaks up and then heats a mineral oil-based fluid that emits a harmless smoke. The smoke is then forced out of the stack by a small electric fan. Smoke volume is controlled by the Proto-Sound 2.0 system.

With a few easy maintenance steps, you should enjoy trouble-free smoke unit operation for years.

When preparing to run this engine, add 15-20 drops of smoke fluid through the smokestack (See figure 16). We recommend M.T.H. ProtoSmoke, Seuthe, LGB, or LVTS fluids. Do not overfill the unit or the fluid may leak out and coat the interior engine components.

If you choose not to add the fluid (or have already added the fluid but choose to run smoke-free), turn off the smoke unit switch located under the water hatch on the right side of the tender (See figure 17). **Failure either to add fluid to the unit or to turn it off may damage the smoke unit heating element and/or wick material.**

When the smoke output while running the engine begins to diminish, add another 10-15 drops of smoke fluid or turn the smoke unit off.

When storing the unit for long periods of time, you may want to add about 15 drops of fluid to prevent the wick from drying out.

After removing the engine from storage, add another 25 drops of fluid, letting the wick soak up the fluid for 15 minutes prior to operation.

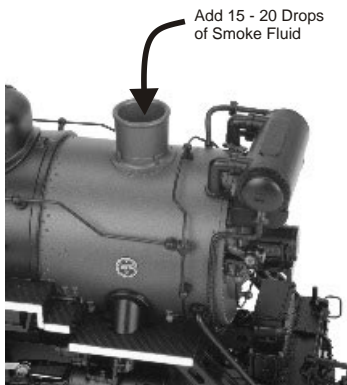

Figure 16

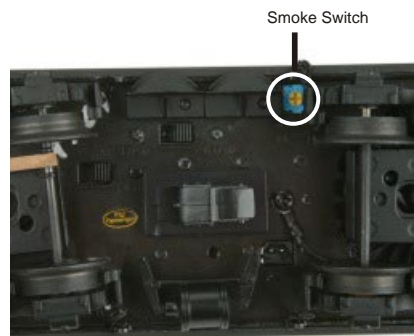

Figure 17

If you experience poor or no smoke output when the smoke unit is on and has fluid, check the wick to see if it has become hard, blackened, and unabsorbent around the heating element. To remove the smoke unit you will first have to remove the boiler shell (by removing the body mounting screws shown in Fig. 11 on pg. 14).

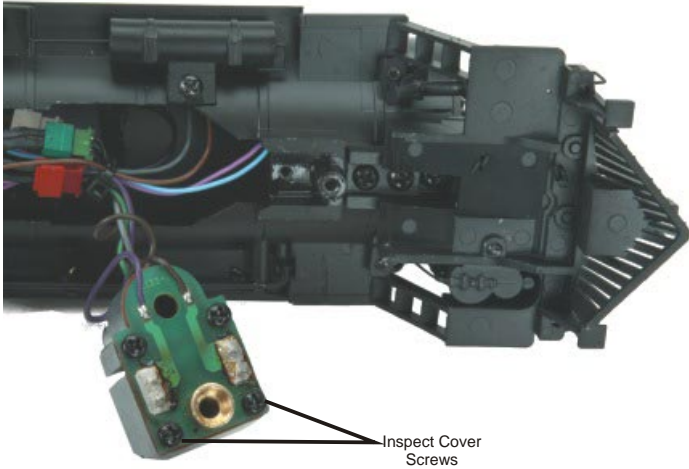

Figure 18

1. Once the boiler has been removed, remove the inspection cover (See figure 18). Inspect the wick; if it is darkly discolored and hard, it should be replaced.

Replacement parts and wick replacement instructions are available directly from the M.T.H. Parts Department phone: 410-381-2580; e-mail: parts@mh-railking.com; 7020 Columbia Gateway Drive, Columbia MD 21046-1532

Troubleshooting Proto-Sound® 2.0 Problems

Although Proto-Sound 2.0 has been designed and engineered for ease of use, you may have some questions during initial operation. The following table should answer most questions. If your problem cannot be resolved with this table, contact M.T.H. for assistance (telephone: 410-381-2580; fax: 410-423-0009; service@mt-h-railking.com, 7020 Columbia Gateway Drive, Columbia MD 21046-1532).

Starting Up	Remedy
When I first turn the power on, the engine will not begin to run.	This is normal behavior. To prevent accidental high-speed start-ups, Proto-Sound 2.0 is programmed to start up in neutral anytime track power has been turned off for several seconds. See the "Basic Operation" section for more details.
The engine will not start after I press the Direction button.	You may not be sending enough power to the track to power the engine. Rotate throttle clockwise to increase track power.
My engine sounds are distorted and garbled.	The battery may have run down, especially if the engine has been in storage for some time. See the "Self-Charging Battery Back-Up" section of these instructions for how to test, recharge, and (if necessary) replace the battery.
Horn	Remedy
I can't get the horn to blow when I press the Horn button.	You may be pressing the button too quickly. Try pressing the Horn button more slowly, taking approximately one full second to fully depress the button.
Bell	Remedy
I can't get the bell to ring when I press the bell button.	You may be pressing the button too quickly. Try pressing the bell button more slowly, taking approximately one full second to fully depress the button.
Coupler	Remedy
When I try to fire the coupler, FYS starts.	You are waiting too long between Horn button presses. See the timing instructions located at the beginning of the "Proto-Sound 2.0 Operating Instructions" section.
The Proto-Coupler won't let the engine uncouple on the fly.	Try lubricating the coupler knuckle and rivet with a dry graphite lubricant.
The coupler does not fire or stay coupled.	The coupler needs to be cleaned. Wipe with denatured alcohol (not rubbing alcohol) and let dry.
The rear coupler does not fire, but coupler sounds play.	Check position of Auxiliary Proto-Coupler Control Switch. Switch Should be in the "OFF" position for the rear coupler to fire.
Cab Chatter	Remedy
Sometimes the Cab Chatter sounds don't play.	Cab Chatter plays only in neutral at random intervals.

Lock-out	Remedy
I can't get the engine to run after I power up the transformer. It sits still with the diesel and compressor sounds running. The engine won't lock into forward, neutral, or reverse.	The engine maybe locked into the neutral position. Follow the procedure in the "Lock into a Direction" section to unlock the engine's direction. Engine speed must be below 10 scale mph (approx. 10 volts or less in conventional mode).
Volume	Remedy
The sounds seem distorted, especially when the Horn or bell is activated.	Proto-Sound 2.0 volume is set too high. Turn the volume control knob on the bottom of the chassis counter-clockwise to reduce the volume.
No Sound	Volume is set too low, adjust volume control knob on the bottom of the chassis clockwise to increase the volume or check connector to speaker.
Battery	Remedy
The engine will not leave the initial neutral setting.	Check to be sure the battery is installed and fully charged. See the "Self-Charging Battery Back-Up" section.
I get no sounds when the engine shifts between directions.	The battery may be dead or need to be charged. See the "Self-Charging Battery Back-Up" section.
After I turn off my transformer, my engine continues to make sounds before quitting.	Proto-Sound 2.0 is designed to continue to sound for a few seconds after power to the track has been shut off to allow for a more realistic shut-down.
PSA	Remedy
Once in PSA, the engine doesn't go into reverse.	So that PSA effects can be as realistic as possible, Proto-Sound 2.0 disables the reversing unit whenever PSA is enabled. This way the engine remains still at its stop as the operator cycles through the PSA sequences.
When the PSA enters its last sequence the bell automatically comes on	PSA is programmed to start ringing the bell at that point. After approximately 12 seconds, it will automatically turn off.
When PSA is enabled, pressing the whistle and bell has no effect	Because PSA must control various effects in each sequence, Proto-Sound 2.0 takes control of these sound effects until you exit PSA
I push the direction button but the next sound clip in the sequence does not play or the engine does not come out of PSA after fourth press of the direction button.	Each PSA clip must play for aprox. 30 seconds before PSA will advance to the next step in the PSA cycle. Wait at least 30 seconds in each PSA sound clip before pressing the direction button.

Transformer Compatibility and Wiring Chart

Proto-Sound 2.0 is designed to work with most standard AC transformers. The chart below lists the many compatible transformers. Note that many of the operational commands described in these instructions require a bell button, so if your transformer does not have its own bell button, you should consider adding one to get the full benefit of the system. In addition, the chart details how the terminals on these transformers should be attached to your layout.

Transformer Model	Center Rail	Outside Rail	Min/Max. Voltage	Power Rating	Transformer Type
MTH Z-500	Red Terminal	Black Terminal	0-18v	50-Watt	Electronic
MTH Z-750	Red Terminal	Black Terminal	0-21v	75-Watt	Electronic
MTH Z-1000	Red Terminal	Black Terminal	0-14v 0-18v	80-Watt 100-Watt	Electronic
MTH Z-4000	Red Terminal	Black Terminal	0-22v	390-Watt	Electronic
Lionel 1032	U	A	5-16v	90-Watt	Standard
Lionel 1032M	U	A	5-16v	90-Watt	Standard
Lionel 1033	U	A	5-16v	90-Watt	Standard
Lionel 1043	U	A	5-16v	90-Watt	Standard
Lionel 1043M	U	A	5-16v	90-Watt	Standard
Lionel 1044	U	A	5-16v	90-Watt	Standard
Lionel 1053	U	A	8-17v	60-Watt	Standard
Lionel 1063	U	A	8-17v	60-Watt	Standard
All-Trol	Left Terminal	Right Terminal	0-24v	300-Watt	Electronic
Dallee Hostler	Left Terminal	Right Terminal			Electronic
Lionel LW	A	U	8-18v	75-Watt	Standard
Lionel KW	A or B	U	6-20v	190-Watt	Standard
Lionel MW	Outside Track Terminal	Inside Track Terminal	5-16v	50V.A.	Electronic
Lionel RS-1	Red Terminal	Black Terminal	0-18v	50V.A.	Electronic
Lionel RW	U	A	9-19v	110-Watt	Standard
Lionel SW	U	A	Unknown	130-Watt	Standard
Lionel TW	U	A	8-18v	175-Watt	Standard
Lionel ZW	A,B,C or D	U	8-20v	275-Watt	Standard
Lionel Post-War Celebration Series ZW	A,B,C or D	Common	0-20v	135/190 Watt	Electronic

*Conventional Mode Only

Additional Features Accessible With The DCS Remote Control System (Additional equipment required)

While conventional mode operation of a Proto-Sound 2.0 engine yields wonderfully realistic sound and several train control features, command mode operation allows the user to access a world of command functions never before accessible to O Gauge railroaders. With the addition of the DCS Remote Control System (including a DCS remote handheld and Track Interface Unit) users gain many advanced features, including:

- DCS Proto-Speed Control - Establishes desired locomotive speed in scale miles per hour increments via a thumbwheel control and allows operator to set maximum speed and acceleration/deceleration rates
- ProtoSmoke® Variable Output Control - Controls how much smoke each engine outputs and matches smoke to locomotive speed
- Locomotive Lighting Control - Controls locomotive headlights, marker and interior lights, beacon lights, ditch lights, and MARS lights
- Emergency Stop-Single button push stops all Proto-Sound 2.0 trains but does not turn off the power
- One Touch Global Mute/UnMute-Single button mutes or unmutes all DCS-controlled locomotives' user-defined actions, including sound, lights, and smoke
- Proto-Dispatch Operation-Public Address-like feature allows users to speak through locomotive speaker during operation
- Proto-Cast-Allows users to play audio recordings through locomotive speaker during operation
- Proto-Doppler Sound Effects Set Up-Users can configure locomotive for Doppler Operation, including setting distance points for Doppler start, repeat, and stop modes
- Independent Volume Control of Engine Sounds, Bell, Horn & Whistle for each Locomotive
- Control up to 50 different DCS-Equipped Locomotives at one time with multiple TIUs
- Proto-Effects™ Set Up-User can select individual Proto-Effects™ operations to be active or inactive, including cab chatter, train wreck sounds, coupler sounds, and wheel clickety-clack sounds
- Direction Control Set Up-User can set initial individual start-up direction start in forward or reverse) for double-heading operations
- Locomotive Consist Set-up-User can determine locomotive values for consist make-ups, allowing multiple locomotives belonging to a consist to operate together

Service & Warranty Information

How to Get Service Under the Terms of the Limited One-Year Warranty

When you suspect an item is defective, please check the operator's manual for standard operation and trouble-shooting techniques that may correct the problem. Additional information may be found on the M.T.H. Website. Should you still require service, follow the instructions below to obtain warranty service.

First, e-mail, write, call or fax a M.T.H. Authorized Service Center (ASC) in your area to obtain Repair Authorization. You can find the list of ASCs on the M.T.H. Website, www.mth-railking.com. Authorized Service Centers are required to make warranty repairs on items sold *only* from that store; all other repairs may-- or may not be done at the store's own discretion. If you did not purchase the item directly from the ASC, you will need to select a National Authorized Service Center (NASC). These centers are compensated by M.T.H. to perform warranty service for any customer whose repair qualifies for warranty service. A list of NASC retailers can be located on the M.T.H. Website or by calling 1-888-640-3700. Should the warranty no longer apply, you may choose either an ASC or NASC retailer to service your M.T.H. Product. A reasonable service fee will be charged.

CAUTION: Make sure the product is packed in its original factory packaging including its foam and plastic wrapping material to prevent damage to the merchandise. There is no need to return the entire set if only one of the components is in need of repair *unless otherwise instructed by the Service Center. **The shipment must be prepaid and we recommend that it be insured. A cover letter including your name, address, daytime phone number, e-mail address (if available), Return Authorization number (if required by the service center, a copy of your sales receipt and a full description of the problem must be included to facilitate the repairs. Please include the description regardless of whether you discussed the problem with a service technician when contacting the Service Center for your Return Authorization.***

Please make sure you have followed the instructions carefully before returning any merchandise for service. Authorized M.T.H. Service Centers are independently owned and operated and are not agents or representatives of M.T.H. Electric Trains. M.T.H. assumes no responsibility, financial or otherwise, for material left in their possession, or work done, by privately owned M.T.H. Authorized Service Centers.

If you need assistance at any time email MTH Service at service@mth-railking.com, or call 410 381-2580.

Limited One-Year Warranty

All M.T.H. products purchased from an Authorized M.T.H. Train Merchant are covered by this warranty.

See our website at www.mth-railking.com or call 1-888-640-3700 to identify an Authorized M.T.H. Train Merchant near you.

M.T.H. products are warranted for one year from the date of purchase against defects in material or workmanship, excluding wear items such as light bulbs, pick-up rollers, batteries, smoke unit wicks, and traction tires. We will repair or replace (at our option) the defective part without charge for the parts or labor, if the item is returned to the M.T.H. Authorized Service Center (ASC) where it was purchased or a M.T.H. National Authorized Service Center (NASC) within one year of the original date of purchase. This warranty does not cover damages caused by improper care, handling, or use. Transportation costs incurred by the customer are not covered under this warranty.

Items sent for repair must be accompanied by a return authorization number, a description of the problem, and a **copy of the original sales receipt from an Authorized M.T.H. Train Merchant**, which gives the date of purchase. If you are sending this product to an Authorized Service Center, contact that Center for their return authorization.

This warranty gives you specific legal rights, and you may have other rights that vary from state to state. Specific questions regarding the warranty may be forwarded to M.T.H. directly.

Service Department
M.T.H. Electric Trains
7020 Columbia Gateway Drive
.Columbia MD 21046-1532



AUTHORIZED SERVICE CENTER

7020 Columbia Gateway Dr. - Columbia, MD 21046

Information: 410-381-2580 Fax: 410-381-6122

www.mth-railking.com

PARTICIPATING A.S.C. RETAILER LIST

ALABAMA

SOUTHERLAND STATION
HUNTSVILLE
256-533-4720

ARIZONA

ARIZONA TRAIN DEPOT
MESA
480-833-9486

CALIFORNIA

CENTRAL COAST TRAINS
ATASCADERO
805-466-1391

TRAIN SHACK
BURBANK
818-842-3330

REED'S HOBBY SHOP
LA MESA
619-464-1672

ROUNDHOUSE
NORTH HOLLYWOOD
818-769-0403

DOLLHOUSES, TRAINS &
MORE
NOVATO
415-883-0388

TIN PLATE JUNCTION
OAKLAND
510-444-4780

RON'S WORLD
SAN CLEMENTE
949-361-5596

BLACK NIGHT TRAINS &
HOBBIES
SANTA ROSA
707-523-3522

COLORADO

CUSTOM RAILWAY SUPPLY
COLORADO SPRINGS
719-634-4616

CABOOSE HOBBIES, INC.
DENVER
303-777-6766

MIZELL TRAINS
WESTMINSTER
303-429-4811

CONNECTICUT

TIME MACHINE HOBBY, LL C
MANCHESTER
860-646-0610

FLORIDA

AMHERST DEPOT
ENGLEWOOD
941-475-2020

DEPOT HOBBY SHOP
IANTANA
561-585-1982

HOLLYWOOD STATION
MIAMI
954-921-2700

READY TO ROLL
MIAMI
305-688-8868

COLONIAL PHOTO & HOBBY
ORLANDO
407-841-1485

WARRICK CUSTOM HOBBIES
PLANTATION
954-370-0708

ROUNDHOUSE SOUTH
PORT ORANGE
386-304-7002

ILLINOIS

BERWYN'S TOY TRAINS &
MODELS
BERWYN
708-484-4384

CHICAGOLAND HOBBY
CHICAGO
773-775-4848

BILL'S ENGLEWOOD STATION
ORLAND PARK
708-460-4906

BIKE & CHOO CHOO
CONNECTION
SCHAUMBURG
847-882-7728

INDIANA

Y. O. R. K. TRAINS
MUNSTER
219-838-9999

SAMUELSON'S TRAIN SHOP
VALPARAISO
219-462-2708

IOWA

CABOOSE STOP HOBBIES
CEDAR FALLS
800-642-7012

KANSAS

HOBBY HAVEN
OVERLAND PARK
913-381-3111

KENTUCKY

L & N TRAINS & THINGS
LOUISVILLE
502-897-9005

LOUISIANA

AMERICA'S TRAIN YARD
BATON ROUGE
225-926-5592

MAINE

WHEELS, WINGS & THINGS
LUDLOW
207-532-6277

MARYLAND

HOBBYTOWN U S A
FREDERICK
301-694-7395

FREDERICK JUNCTION
FREDERICK
301-694-3434

ENGINE HOUSE HOBBIES
GAITHERSBURG
301-590-0816

J & B TRAINS
HAGERSTOWN
240-420-4930

THE TRAIN ROOM
HAGERSTOWN
301-745-6681

PURKEY'S TOY TRAINS
SYKESVILLE
410-549-6061

CATOCTIN MOUNTAIN TRAINS
& HOBBIES
THURMONT
301-694-8331

E.L. JONES & SONS
WILLIAMSPORT
800-810-8138

MASSACHUSETTS

FLYING YANKEE HOBBY
SHOP
BOSTON
617-323-9702

NORTHEAST TRAINS
PEABODY
978-532-1615

EAST BAY HOBBIES
SEEKONK
508-336-5573

PIONEER VALLEY HOBBIES
W. SPRINGFIELD
413-732-5531

MICHIGAN

MICHIGAN MODEL TRAIN
CENTER
PINCKNEY
734-426-1651

BRASSEUR ELECTRIC
TRAINS INC.
SAGINAW
989-793-4753

MINNESOTA

DON'S HOBBY CO.
MANKATO
507-387-1330

MISSOURI

SWITCH STAND
SAINT LOUIS
314-781-4458

MARK TWAIN HOBBY CENTER
ST. CHARLES
636-946-2816

NEVADA

RENO RAILS
RENO
775-337-6669

NEW HAMPSHIRE

TREASURED TOYS
SALEM
603-898-7224

NEW JERSEY

HOBBY SHOP
ABERDEEN
732-583-0505

COUNTRY AND STUFF
ANDOVER
973-786-7086

GENE'S TRAINS
BRICK
732-840-9728

COLUMBUS TRAIN STATION
COLUMBUS
609-518-1800

ATLANTIC RAILS
HAMMONTON
609-567-8490

C B TRAIN DEPOT
HILLSDALE
201-666-9598

GRAND CENTRAL STATION
KEARNY
201-955-6200

J & B TRAINS, INC.
MAPLE SHADE
856-414-0092

HOBBYMASTERS, INC
RED BANK
732-842-6020

RIDGEFIELD HOBBY
RIDGEFIELD
201-943-2636

TOM'S MODEL TRAINS
SCOTCH PLAINS
908-322-6122

TRAINS & THINGS
TRENTON
609-883-8790

HOLLY BEACH TRAIN DEPOT
WILDWOOD
609-522-2379

NEW YORK

L B C MODEL TRAINS
BUFFALO
716-631-3081

KURT'S TRAINS & HOBBIES
CALEDONIA
585-538-2960

AURORA RAILS & HOBBIES
EAST AURORA
716-652-5718

NASSAU HOBBY CENTER,
INC.
FREEPORT
516-378-9594

J & R JUNCTION
LIVERPOOL
315-451-6551

HOBBY WORLD
MONTICELLO
845-794-8770

CITY DEPOT, INC.
NEW HAMPTON
845-374-3010

THIRD STREET DEPOT
NIAGARA FALLS
716-285-6464

ISLAND TRAINS
STATEN ISLAND
718-317-0008

SCAG'S ELECTRIC TRAIN
SHOP
STATEN ISLAND
718-727-7373

AMERICANA STORE
TIVOLI
845-757-4246

KROSS HARDWARE
WEST BABYLON
631-669-3069

WESTCHESTER CENTRAL
TRAINS
WHITE PLAINS
914-421-1262

NORTH CAROLINA

THE ROUNDHOUSE &
BACKSHOP
CARY
919-465-0810

DRY BRIDGE STATION
MOUNT AIRY
336-786-9811

THE FREIGHT YARD
SMITHFIELD
919-934-6229

LITTLE CHOO CHOO SHOP
INC.
SPENCER
704-637-8717

TRAIN LOFT
WINSTON-SALEM
336-760-9817

OHIO
E & S TRAINS
AKRON
330-745-0785

T & K HOBBY SHOP
BRIDGEPORT
740-633-6607

PARMA HOBBY
CLEVELAND
216-741-6440

SANDY'S HOBBY'S &
COLLECTIBLES
ELYRIA
440-365-9999

DUNHAM'S TOY TRAINS
LONDON
740-852-0899

CLEARVIEW TRAIN & HOBBY
LORAIN
440-277-4488

DIXIE UNION STATION
MASON
513-459-0460

DAVIS TRAINS
MILFORD
1-800-448-1060

ERIE RAILWAY DEPOT
TROY
937-440-9922

PENNSYLVANIA
AMERICAN HOBBY CENTER
ALIQUIPPA
724-378-3930
BUSSINGER TRAINS
AMBLER
215-628-2366

JIM'S HOBBY SERVICE
BERWICK
570-759-2695

YE OLDE TRAIN &
CHRISTMAS SHOPPE
BOYERTOWN
610-369-0755

NICHOLAS SMITH TRAINS
BROOMALL
610-353-8585

CHARLEROI SWEEPER
CENTER
CHARLEROI
724-483-3397

JERRY QUINN TRAINS & TOYS
COATESVILLE
610-383-1931

CRANBERRY HOBBY DEPOT
CRANBERRY TWP
724-776-3640

FAIRCHANCE PHARMACY
FAIRCHANCE
724-564-7817

TRAINS R FUN
FRAZER
610-644-4585

THE CABOOSE
LEHIGHTON
570-386-5352

SCHUYLKILL FLYER HOBBIES
LEESPORT
484-248-2100

HOBBY CITY
McMURRAY
724-942-2557

ENGLISH MODEL RR
MONTOURSVILLE
800-327-5126

STATION/M H INDUSTRIES
NEW CUMBERLAND
717-774-7096

FRYER'S STORE
ORWIGSBURG
570-366-2258

TOBY TYLER'S HOBBY
CENTER
PITTSBURGH
412-653-5030

WILCOX GREENHOUSE &
NURSERY
TITUSVILLE
814-827-3823

EASTERN DEPOT
TROY
570-297-1975

J & J RAILROAD CROSSING
INC
TURTLE CREEK
412-824-6009

THE TRAIN SHOPPE & HOBBY
CENTER LD
WILKES BARRE
570-824-7688

RHODE ISLAND
GRANDMA'S HOUSE
GRANDPA'S TRAIN
WARWICK
401-463-7803

SOUTH CAROLINA
EMERALD TRAIN & HOBBY
GREENWOOD
864-223-2247

TENNESSEE
MODEL RAILROAD & HOBBY
SHOP
MEMPHIS
901-384-6500

TRAINS-N-THINGS
PARIS
731-641-8880

TEXAS
HOBBY TIME
AMARILLO
806.352.9660

RIVERVIEW TRAINS
ANGLETON
979-848-3895

GREAT TRAINS & HOBBIES
LONGVIEW
903-757-2720

UTAH
ALMOSTA JUNCTION
CLEARFIELD
801-776-1656

VIRGINIA
LEESBURG HOBBIES &
COLLECTIBLES
LEESBURG
703-779-8600

LOCUST GROVE TRAINS
LOCUST GROVE
540-854-8955

TRAINS, ETC.
LORTON
703-550-1779

TRAIN DEPOT
MANASSAS
703-335-2216

CHESTERFIELD HOBBIES
MIDLOTHIAN
804-379-9091

DAVIS HOBBY SUPPLIES
PORTSMOUTH
757-397-1983

TOY TRAIN CENTER
RICHMOND
804-288-4475

T S G HOBBIES
WARRENTON
540-347-9212

NORGE STATION
WILLIAMSBURG
757-564-7623

WASHINGTON
EASTSIDE TRAINS
KIRKLAND
425-828-4098

WEST VIRGINIA
PATRICK'S TRAINS
WHEELING
304-232-0714

WISCONSIN
WOODCRAFTERS SHOP
BURLINGTON
262-763-5239

SOMMERFELD'S TRAINS
BUTLER
262-783-7797
HOBBY OUTLET
FOND DU LAC
920-924-3770

G B T V & TRAINS
GREEN BAY
920-496-9697

GRAMPA'S TRAIN SHOP
RICE LAKE
715-234-2996

CANADA
TOY TRAIN WORKSHOP
CUMBERLAND
613-833-8331

THE TRAIN ROOM
FERGUS
19-787-3280

CREDIT VALLEY RAILWAY
COMPANY
TREETSVILLE
905-826-1306

B&H TRAINS
TERREBONNE
514-793-9696

PARTICIPATING N.A.S.C. LIST

CALIFORNIA
TIN PLATE JUNCTION
OAKLAND
510-444-4780

COLORADO
MIZELL TRAINS
WESTMINSTER
303-429-4811

CONNECTICUT
TIME MACHINE HOBBY, LL C
MANCHESTER
860-646-0610

FLORIDA
COLONIAL PHOTO & HOBBY
ORLANDO
407-841-1485

ROUNDHOUSE SOUTH
PORT ORANGE
386-304-7002

ILLINOIS
CHICAGOLAND HOBBY
CHICAGO
773-775-4848

KENTUCKY
L&N TRAINS & THINGS
LOUISVILLE
502-897-9005

MARYLAND
ENGINE HOUSE HOBBIES
GAITHERSBURG
301-590-0816

CATOCTIN MOUNTAIN TRAINS
& HOBBIES
THURMONT
301-694-8331

MICHIGAN
MICHIGAN MODEL TRAINS
PINCKNEY
734-426-1651

BRASSEUR ELEC. TRAINS
SAGINAW
989-793-4753

NEW HAMPSHIRE
TREASURED TOYS
SALEM
603-898-7224

NEW YORK
L B C MODEL TRAINS
BUFFALO
716-631-3081

AURORA RAILS & HOBBIES
EAST AURORA
716-652-5718

THIRD STREET DEPOT
NIAGARA FALLS
716-285-6464

OHIO
DAVIS TRAINS
MILFORD
1-800-448-1060

PENNSYLVANIA
BUSSINGER TRAINS
AMBLER
215-628-2366

JIM'S HOBBY SERVICE
BERWICK
570-759-2695

FAIRCHANCE PHARMACY
FAIRCHANCE
724-564-7817

ENGLISH MODEL RR
MONTOURSVILLE
800-327-5126

TOBY TYLER'S HOBBY CEN.
PITTSBURGH
412-653-5030

VIRGINIA
LOCUST GROVE TRAINS
LOCUST GROVE
540-854-8955

DAVIS HOBBY SUPPLIES
PORTSMOUTH
757-397-1983

T S G HOBBIES
WARRENTON
540-347-9212

WISCONSIN
SOMMERFELD'S TRAINS
BUTLER
262-783-7797

GRAMPA'S TRAIN SHOP
RICE LAKE
715-234-2996

CANADA
TOY TRAIN WORKSHOP
CUMBERLAND
13-833-8331

THE TRAIN ROOM
FERGUS
519-787-3280