

*RAILKING*  
**READY-TO-RUN™**  
*sets*  
**THE COMPLETE SOLUTION**

[www.railking.com](http://www.railking.com)

# Chicago NorthWestern 2-8-0 Steam Freight Set

Operation Manual



**RAILKING**  
By MICHIGAN TRAINS

Thank you for purchasing this RailKing product.  
**PLEASE READ BEFORE USE AND SAVE**

# Table of Contents

Setup Checklist.....	3
Getting Started.....	4
Assembling Real Trax.....	4
Plugging in the Transformer.....	4
Lubricating the Engine.....	5
Priming the Smoke Unit.....	5
Coupling the Engine and Cars.....	6
Remote Control.....	6
Basic Operation.....	7
Operation Buttons.....	7
Speed Control.....	8
Direction Lock.....	8
Proto-Cast and Proto-Dispatch.....	9
Manual Volume Control.....	10
Maintenance.....	11
Care of Remote Control.....	11
Lubrication and Greasing Instructions.....	11
Cleaning the Wheels, Tires and Track.....	12
Locomotive Traction Tire Replacement.....	12
Smoke Unit Maintenance.....	12
Locomotive Light Bulb Replacement.....	13
Caboose Light Bulb Replacement.....	14
RailWare Interactive CDROM.....	15
Troubleshooting.....	16
Compatibility.....	17
Transformer Compatibility Chart.....	17
Exploded View Parts.....	18
Service and Warranty Information	

## CAUTION: ELECTRICALY OPERATED PRODUCT:

Not recommended for children under 10 years of age. M.T.H. recommends adult supervision with children ages 10-16. As with all electric products, precautions should be observed during handling and use to reduce the risk of electric shock.

## WARNING: When using electrical products, basic safety precautions should be observed, including the following:

Read this manual thoroughly before using this device.

- M.T.H. recommends that all users and persons supervising use examine the hobby transformer and other electronic equipment periodically for conditions that may result in the risk of fire, electric shock, or injury to persons, such as damage to the primary cord, plug blades, housing, output jacks or other parts. In the event such condition exist, the train set should not be used until properly repaired.
- Do not operate your layout unattended. Obstructed accessories or stalled trains may overheat, resulting in damage to your layout.
- This train set is intended for indoor use. Do not use if water is present. Serious injury or fatality may result.
- Do not operate the hobby transformer with damaged cord, plug, switches, buttons or case.
- The transformer was designed to operate on regular US household current (120 volt, 50-60 Hertz). Do not connect to any other source of power.
- To avoid the risk of electrical shock, do not disassemble the transformer unit. There are nouser-serviceable parts inside. If the unit is damaged contact M.T.H. Service for instructions.
- The transformer is equipped with an internal circuit protector. If the circuit protector trips, unplug the power cord from the electrical wall outlet, check your layout for any short circuits. The circuit breaker will reset automatically when the shorts removed from the circuit.
- Unplug the transformer from the electrical wall outlet when not in use.
- Do not use this transformer for other than its intended purpose.

## Transformer Ratings:

Input: 120VAC, 60Hz Only, Output: 21VAC, 3.75A/78VA

# Set Up Checklist

- Assemble RealTrax®
- Connect the transformer
- Lubricate the engine
- Prime the Smoke Unit
- Place the engine and cars on the track and couple them together
- Position remote lock-on lens
- Apply power to run as described in the Basic Operation section of these instructions.

## Set Includes



Steam Engine with Loco-Sound™



Steam Tender



8-Pieces  
O-31 Curve RealTrax



Track Clips



Box Car



Tank Car



Caboose



Lock-On



Remote Control



CD-Rom



Video

## Tools Needed



Philips Screwdriver



Pliers



Scissors



Cotton Swab or Rag



Rail King Maintenance Kit  
Light, Household Oil, and Bearing Grease

## Optional Equipment



Microphone w/ 1/8" Plug



1/8" Male to Male Plug



Cassette Player

**You can obtain replacement parts and replacement instructions from the M.T.H. Parts Department**

e-mail: [parts@meth-railking.com](mailto:parts@meth-railking.com)

phone: 410-381-2580

mail: 7020 Columbia Gateway Drive, Columbia MD 21046-1532

# Getting Started

## Assembling RealTrax<sup>®</sup>

The quick connectors and built-in road bed allow you to set up RealTrax anywhere, including carpeted surfaces.

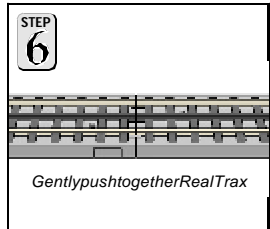
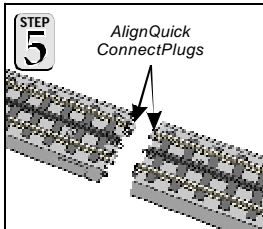
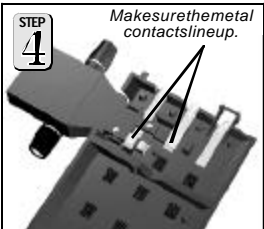
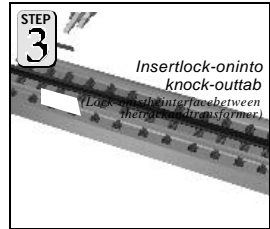
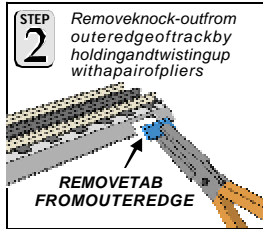
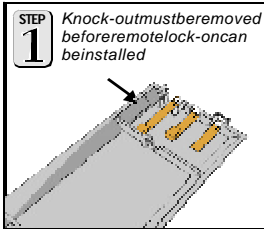

### Connecting TrackClips

If you prefer not to screw your track to the table for a permanent layout, use the enclosed track clips on adjoining curved RealTrax sections to secure them in place.

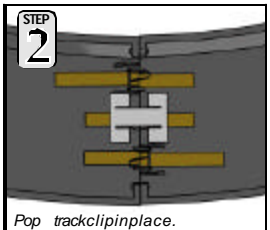
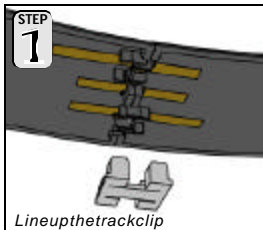

### Connecting the Transformer

The 75-watt power supply included with this set provides an easy-to-use, safe power source for AC-powered trains and accessories.

- Plug the wire from the transformer into the remote lock-on's center port, then plug the transformer into the wall outlet.
- Unplug when not in use.

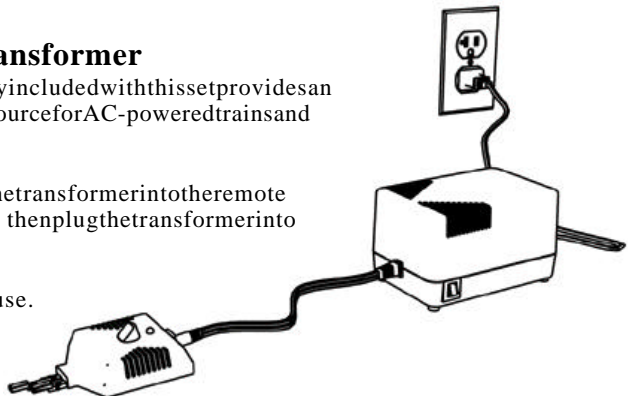

## Lubricating the Engine

Lubricate all exposed moving parts before operating using a multi-purpose, plastic-compatible oil (available with M.T.H.'s Maintenance Kit, sold separately) or a light household oil. Follow the lubrication points.

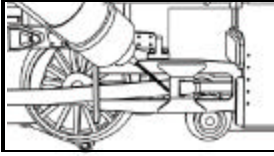

Lubricate Valve Gear

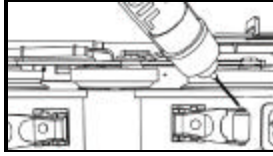

Lubricate Pick-Up Rollers  
*(Do Not Oil the Flat Part of Pick-Up Rollers)*

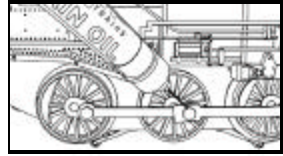

Lubricate Side Rods

## Priming the Smoke Unit

You should prime the smoke unit with smoke fluid before operating. Add 15-20 drops of smoke fluid from the included pipette through the smoke stack, then gently blow into the stack to eliminate any air bubbles in the fluid.

If you choose not to prime the unit with fluid, turn the smoke unit switch located under the tender to the OFF position. **Running the engine without a primed smoke unit may cause damage.** See the "Proto Smoke Unit Operation" section of this book for more information on smoke unit maintenance.

Add 15-20 Drops  
Smoke Fluid

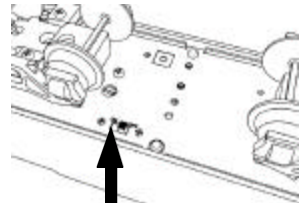
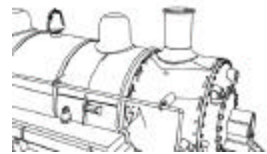

Smoke Unit  
ON/OFF Switch



**Running the engine without a primed smoke unit may cause damage**

## Coupling the Engine and Cars

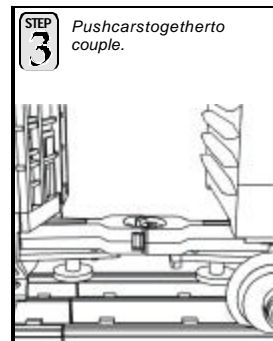
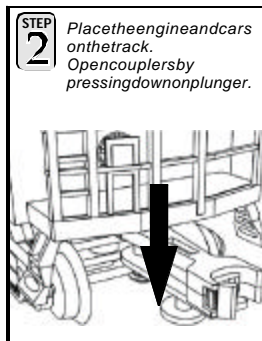
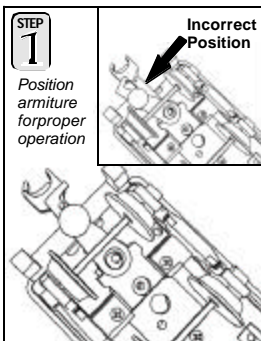

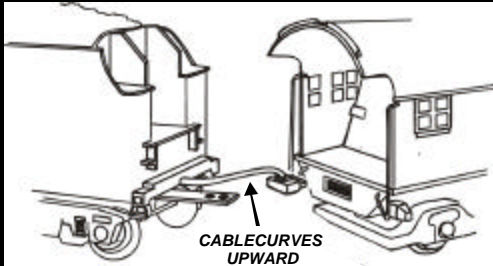

- Plug tender plug into boiler socket at the back of cab.
- Connect the drawbar between the engine and tender.



**DONOTCONNECT  
This Engine To A  
Tender From  
Another Engine; It May  
Cause Serious Damage.**

*Look at the bottom of the engine and tender where each will have a color-coded stamp. If they match you may connect those two pieces; if not, don't.*

## Remote Control

The remote and lock-on are designed for use with moderate power supplies such as the one included with this set. It is compatible with virtually any manufacturer's engines.

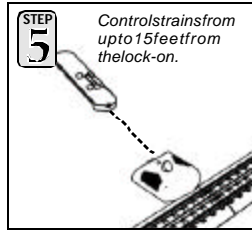
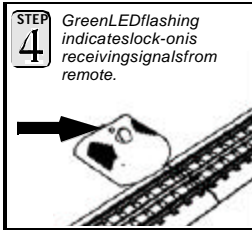
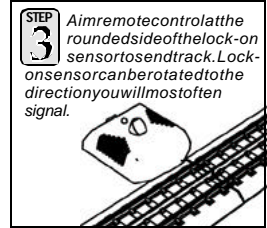
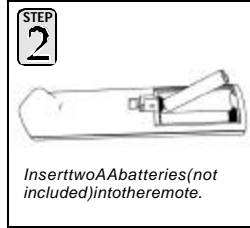
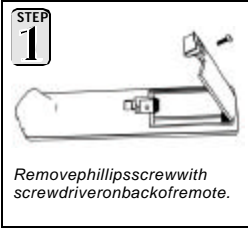

**Note:** The RailKing<sup>®</sup> Remote Control and Remote Lock-on will not operate engines equipped with pre-1997 versions of Proto-Sound<sup>®</sup> or with Proto-One,<sup>™</sup> Proto-Plus,<sup>™</sup> Proto-Deluxe,<sup>™</sup> aftermarket systems.

# Basic Operation

**ThrottleUp** ThrottleupthepowertoourtrackbypressingthetopendoftheThrottle ControlRockerSwitchfirmlyforabout5seconds,untiltheengine'sheadlightand lightedcarsburnbright. Thenputtheengineintomotionbyfirmlypressingthe Directionbutton(holditforapproximately1second)onyourremoteonce. Iftheengine doesnotbegintomoveassoonasyoufirmlypresstheDirectionbutton,youmaynot have sentenoughvoltagegetothetracktomakethetrainmove. Presssthethrottleupfora fewmoresecondsuntilthetrainbeginstomove.

Toincreaseordecreasetrackvoltage,andthereforetrainspeed,presssthethrottlecontrol rockerswitch. Pressingthetopendofthethrottlewillincreasevoltageandspeed. Pressingthebottomendofthethrottlewilldecreasevoltageandspeed.

Theenginewillmaintainthespeedyousetafteryoureleasethethrottleuntilyoupressit againtochangethevoltageandspeed.

**Bell** - Tosoundthebell,firmly pressandreasetheBell button.Toturnthebelloff, pressandreasetheBellbutton again. Thebellwillcontinuetor ringfromthetimeyouturniton untilyoupressandreasethe buttonagaintoturnitoff.

**EmergencyStop** Pressthe EmergencyStopbuttonandall trainsonthetrackcontrolledby theremotewillstopuntilyou reapplyvoltage. Thisisaneasy waytoshutdownyourtrainsat theendofasessionortostop suddenlyifthetrain'spath becomesobstructed.

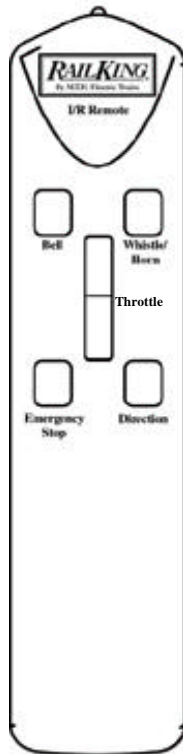

**Horn/Whistle** - Tosoundthehorn, firmlypresstheHorn/Whistle button.Thehornwillsoundforas longasyoucontinuetodepressthe button. Itwillstopwhenyou releasethobutton.

**Direction** Yourtrainis programmedtostartinneutral. Thetrainwillalwayscycle neutral-forward-neutral-reverse witheachpressandreleaseofthe directionbutton. Theengineis programmedtorestartinneutral eachtimethetrackvoltageis turnedofffor25secondsormore.

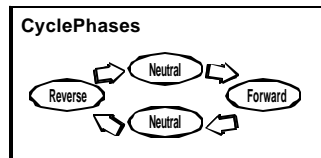

## Speed Control

M.T.H. engines equipped with Loco-Sound have speed control capabilities that allow the engine to maintain a constant speed up and down grades and around curves, much like an automobile cruise control. You can add or drop cars on the run, and the engine will maintain the speed you set.

While the engine is programmed to start with the speed control feature activated, you can opt to turn it off. This means the engine's speed will fall as it labors up a hill and increase as it travels downward. It is also affected by the addition or releasing of cars while on the run. To maintain a constant speed when speed control is turned off, you need to adjust track voltage yourself.

**To turn speed control on and off**, put the engine in neutral, then quickly tap the transformer's Whistle button one time then quickly tap the Bell button two times, allowing approximately 1/2 second to lapse between each quick button press. Repeat the 1 whistle, 2 bells code to return to the other condition. **You will want to do this during the initial neutral upon start-up if you ever couple this engine to another engine that is not equipped with speed control to avoid damaging the motors in either engine.** Each time you shut down the engine completely, it will automatically turn speed control on.

Timing Chart				
Press Whistle Short & Firm	1/2 Sec. Pause	Press Bell Short & Firm	1/2 Sec. Pause	Press Bell Short & Firm
Total Time Lapse: 1 1/2 Seconds				



Place Engine into Neutral



=

Speed Control Repeat to Return to Normal Condition

## Direction Lock

You can lock your engine into a direction (forward, neutral, or reverse) so that it will not change directions. To do this, put the engine into the direction you want and into neutral, to lock it into neutral, run it at a very slow crawl (as slowly as it will move without halting), and quickly but firmly tap the Whistle button once followed by three quick taps of the Bell button, allowing approximately 1/2 second to lapse between each quick button press. The engine will not change direction (including going into neutral) until you repeat the 1 whistle, 3 bells code to return the engine to its normal condition, even if the engine is kept without power for extended periods of time.

Place Engine into Desired Direction



=

Direction Lock Repeat to Return to Normal Condition



## Proto-Cast and Proto-Dispatch:

When used with the remote lock-on included in this set, Loco-Sound equipped engines gain Proto-Cast™ and Proto-Dispatch™ features.

### Proto-Cast:



Allows you to play audio recordings through your engine's speakers. You must supply the audio source (a small portable CD/tape player is sufficient) and a male-to-male mini-cable (1/8" plug, like that used for the headset with a portable CD/tape player) to connect your audio source to the remote lock-on.

### How to Use Proto-Cast

- Plug the mini-cable *first* into your audio source (usually into the headphone jack)
- Plug Cable into the "Audio" port on the right side of the remote lock-on.
- Adjust the volume. If engine sounds keep breaking through the recorded sounds, increase the volume on the audio source.

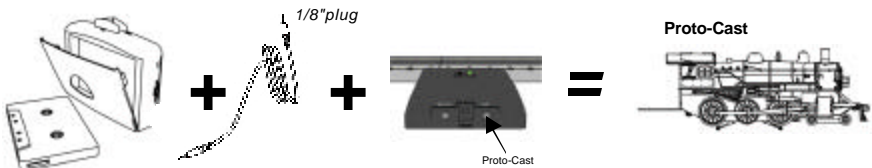

### Proto-Dispatch:



This feature allows you to broadcast your own voice through your engine's speakers. You must supply the microphone and a mini-cable (1/8" plug, like that used for the headset with a portable CD/tape player) to connect your microphone to the remote lock-on.

### How to Use Proto-Dispatch

- Mini-cable attached to the microphone must be a 1/8" plug.
- Plug the "Mic" into the proto-dispatch port on the left side of the remote lock-on and speak into the microphone.



When these features are in use, the locomotive's own sounds (engine sounds and bells, whistles, and horns) will be muted so that only the sounds you broadcast will be heard. Because these two features are voice activated, there will be a several second delay after you stop speaking into the microphone or turn off the audio source before the engine sounds resume. To stop using the feature and return to normal operation, unplug the cable from the lock-on jack.

If using parallel tracks with multiple Loco-Sound equipped engines, Proto-Cast and Proto-Dispatch transmissions from one track may be picked up by the other nearby engines.

If you experience popping and interference when using Proto-Cast or Proto-Dispatch, try cleaning the track with denatured alcohol as described in the "Cleaning the Wheels, Tires and Track" section of this booklet.

**NOTE: M.T.H. does not recommend using Proto-Cast and Proto-Dispatch at the same time.**

## Manual Volume Control

To adjust the volume of all sounds made by this engine, turn the master volume control knob located under the tender clockwise to increase the volume and counter-clockwise to decrease the volume.

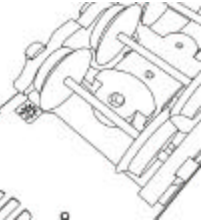

# Maintenance

## Care of the Remote Control

To ensure trouble-free operation:

- Do not drop the remote. It can damage the delicate electronics inside.
- Remove batteries before storing for extended periods.
- Any attempt by anyone other than an authorized M.T.H. repair person to open and repair the handheld transmitter or lock-on may result in damage and the loss of warranty protection.
- If your train responds inconsistently, replace old batteries with fresh ones. Do not mix old and new batteries.

## Lubrication Instructions

The engine should be oiled and greased in order to run properly.

Regularly lubricate all slider rods and linkage components and pick-up rollers to prevent squeaking. Use light household oil, such as that found in M.T.H.'s maintenance kit. Do not overoil. Use only a drop or two on each pivot point.

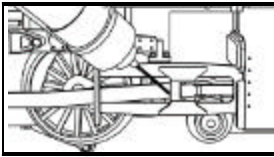

Lubricate Valve Gear

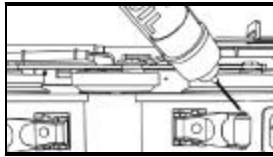

Lubricate Pick-Up Rollers  
(Do Not Oil the Flat Part of  
Pick-Up Rollers)

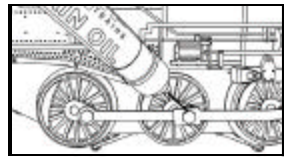

Lubricate Side Rods

## Greasing Instructions

The locomotive's internal gearing was greased at the factory. Grease engine every 50 hours of use or one year. Use lithium based grease and follow the greasing instructions.

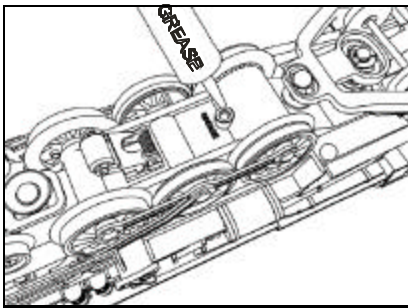

- Remove the screw from the chassis to open the grease port.
- Insert the grease tube tip into the port and squeeze the tube once or twice to add grease to the gearbox.
- Wipe off any excess grease and replace the phillips screw securely.

## Cleaning the Wheels, Tires and Track

Periodically check the locomotive wheels and pickups for dirt and buildup, which can cause poor electrical contact and traction and prematurely wear out the neoprene traction tires. Wheels and tires can be cleaned using denatured (not rubbing) alcohol applied with a cotton swab.



To clean the track, use Rail King Track Cleaning Fluid and a clean rag or denatured (not rubbing) alcohol. Unplug the transformer and wipe the rails of the track, turning the rag frequently to ensure that you are using clean cloth on the rails. Because the manufacturing process leaves a coating on Real Trax center rail, you should clean the rails after the first 30 minutes of use (you may notice an electrical smell during initial use as the coating wears off; this is normal). Thereafter, keep an eye on the track and clean it when it gets dirty to ensure good electrical contact and to lengthen the life of the tires.

## Traction Tire Replacement Instructions

Your locomotive is equipped with two neoprene rubber traction tires on the rear set of flanged drivers. While these tires are extremely durable, you may need to replace them at some point.

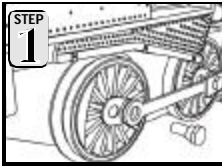

- Remove the siderods (the rods that connect each drive wheel to the other) from the wheels in order to slip the new tire over the grooved drive wheel. These screws can be loosened with a 5mm nut driver.
- Clean the groove using a cotton swab and denatured alcohol.

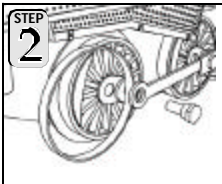

- Make sure the old tire has been completely removed from the groove in the drive wheel, using a razor blade or small flathead screwdriver to pry away any remains.
- Clean the groove using a cotton swab and denatured alcohol.
- Slip the new tire onto the wheel. You may find it useful to use two small flathead screwdrivers to stretch the tire over the wheel.
- If you wish the tire while stretching it over the wheel, you will need to remove and reinstall the tire. Otherwise your engine will wobble while operating.
- Make sure the tire is fully seated inside the groove. Use a razor blade to trim away any excess tire that doesn't seat itself inside the groove properly.

## ProtoSmoke® Unit Operation

This steam locomotive contains a smoke unit that outputs smoke through the smoke stack on the boiler of the engine. The smoke unit is essentially a small heating element and wick that soaks up and then heats a mineral oil-based fluid that emits a harmless smoke. The smoke is then forced out of the stack by a small electric fan.

With a few easy maintenance steps, you should enjoy trouble-free smoke unit operation for years.

- When preparing to run this engine, add 15-20 drops of smoke fluid through the smoke stack. We recommend M.T.H. ProtoSmoke, Seuth, LGB, or LVTS fluids (a

small pipette of Proto Smoke fluid is included). Do not overfill the unit or the fluid may leak out and coat the interior engine components.

- If you choose not to add the fluid (or have already added the fluid but choose to run smoke-free), turn off the smoke units which are located under the tender body. **Failure either to add fluid to the unit or to turn it off may damage the smoke unit heating element and/or wicking material.**

Add 15-20 Drops  
Smoke Fluid

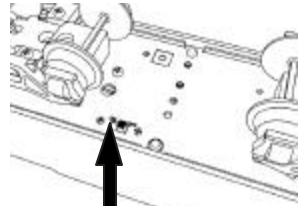

Smoke Unit  
ON/OFF switch



Smoke Unit Cover

### **⚠ Running the engine without a primed smoke unit may cause damage**

- When the smoke output while running the engine begins to diminish, add another 10-15 drops of smoke fluid or turn the smoke unit off.
- When storing the unit for long periods of time, you may want to add about 15 drops of fluid to prevent the wick from drying out.
- After removing the engine from storage, add another 25 drops of fluid, letting the wick soak up the fluid for 15 minutes prior to operation.

If you experience poor or no smoke output when the smoke unit is on and has fluid, check the wick to see if it has become hard, blackened, and unabsorbent around the heating element. Remove the boiler as shown below. Remove the smoke unit inspection cover from the locomotive's body (see right). After removing the chassis and inspection cover screws, lift the inspection plate away and inspect the wick. If it is darkly discolored and hard, it should be replaced. When priming new wick add 40 drops.



Wick in  
Poor  
Condition



Wick in  
Good  
Condition

## Locomotive Light Bulb Replacement

To replace the light bulb in the locomotive, follow the boiler removal instructions below.

STEP  
1

Remove the six Phillips screws from the chassis then lift the body away from the chassis.

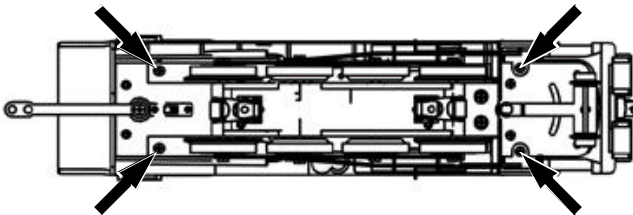

**STEP 2**

Once the locomotive boiler has been removed from its chassis, locate the bulb bracket as seen in the illustration on the right and rotate the headlight bulb counter-clockwise to remove.

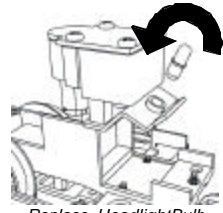

Replace Headlight Bulb

## Caboose Light Bulb Replacement

To replace the interior light bulbs follow these instructions and see the diagrams below.

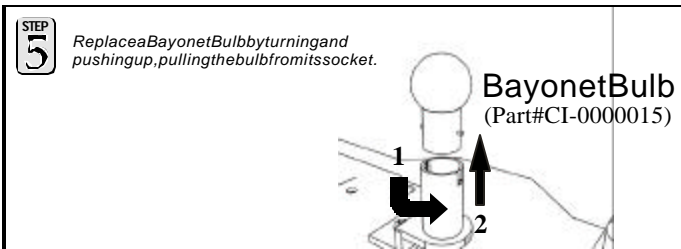
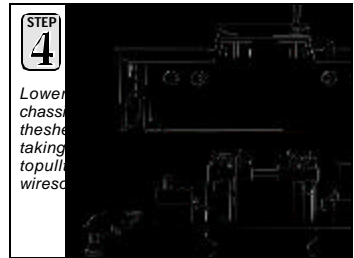
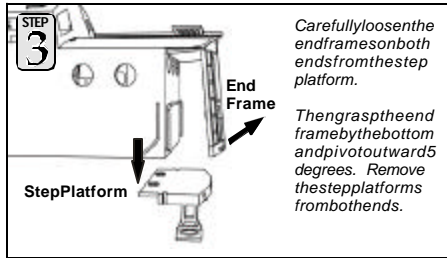
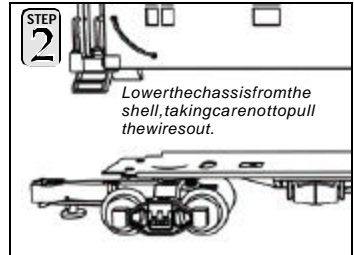
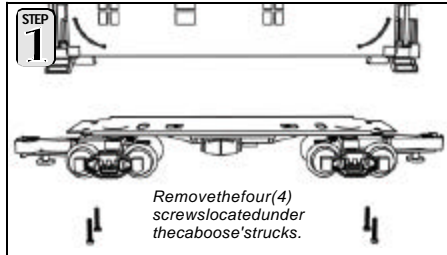

# Quick-Start Video

The included VHS Quick-Start video demonstrates the start-up and basic operation of this set as well as other information about model railroading. You may find it helpful to view the video before operating this set.

# RailWare Interactive CD ROM

M.T.H. provides a free RailWare CD ROM in each Ready-To-Run set. It is full of helpful information on M.T.H. product history, track planning software, a dealer finder, and information and video clips on Loco-Sound and Proto-Sound 2.0. Follow the directions below to use the CD ROM.

Minimum System Requirements: Pentium 100, 16MB RAM, Windows 95 or later, CD ROM drive, Sound Card, display properties set to greater than 256 colors. The CD will not work on a Mac OS unless you run a Virtual PC.

# Running RR-Track Software

You may run the RR-Track software directly off of the CD ROM or you may install the software to your hard drive.

1. On the Desktop, click on the icon that says My Computer.
2. Find your CD ROM drive.
3. With the M.T.H. CD ROM in the drive, double click on the icon for the CD ROM drive.
4. Find the folder on the CD ROM entitled INSTALLATION.
5. Choose the folder inside entitled RRTRAXSETUP.
6. Run the file in that folder called SETUP.EXE and follow the directions it provides.

The program may ask you for a registration code. If it does type in "M.T.H." and it will run.

Additional track libraries can be obtained directly from RR-Track. See their website for more information [www.rtrack.com](http://www.rtrack.com).

# Installing Adobe Acrobat Software

To read some of the electronic documents included on the CD ROM, you will need to install the Adobe Acrobat Reader® if it is not already on your computer. To install the software:

1. On the Desktop, click on the icon that says My Computer.
2. Find your CD ROM drive.
3. With the M.T.H. CD ROM in the drive, double click on the icon for the CD ROM drive.
4. Find the folder on the CD ROM entitled INSTALLATION.
5. Choose the folder inside entitled ACROBATREADER.

\*If you are running Windows 95, 98 or NT choose the folder 32BIT. Run the file AR32E301.EXE and follow the directions it provides.

If you have problems you cannot resolve by using these directions, contact [custserv@mth-railking.com](mailto:custserv@mth-railking.com) or call 410-381-2580 for further help.

# Troubleshooting Loco-Sound™ Problems

Although Loco-Sound has been designed and engineered for ease of use, you may have some questions during initial operation. The following tables should address your most questions. If your problem cannot be resolved with this table, contact M.T.H. for assistance (e-mail: [service@mth-railking.com](mailto:service@mth-railking.com); telephone: 410-381-2580; fax: 410-423-0009; mail: 7020 Columbia Gateway Drive, Columbia MD 21046-1532).

<b>Starting Up</b>	<b>Remedy</b>
When I first turn the power on, the engine will not begin to run.	This is normal behavior. To prevent accidental high-speed start-ups, Loco-Sound is programmed to start up in neutral any time track power has been turned off for several seconds. See the "Basic Operation" section for more details.
The engine will not start after I press the Direction button.	You may not be sending enough power to the track to power the engine. Press the throttle up for a few more seconds to increase track power.
<b>Whistle</b>	<b>Remedy</b>
I can't get the whistle to blow when I press the whistle button.	You may be pressing the button too quickly. Try pressing the whistle button more slowly, taking approximately one full second to fully depress the button.
<b>Bell</b>	<b>Remedy</b>
I can't get the bell to ring when I press the bell button.	You may be pressing the button too quickly. Try pressing the bell button more slowly, taking approximately one full second to fully depress the button.
<b>Lock-out</b>	<b>Remedy</b>
I can't get the engine to run after power up the transformer. It's still with the engine sounds running.	The engine may be locked into the neutral position. Follow the procedure in the "Lock into a Direction" section to <u>unlock the engine's direction</u> .
The engine won't lock into forward, neutral, or reverse.	Engine speed must be below 10 scale mph (approx. 10 volts or less in conventional mode).
<b>Volume</b>	<b>Remedy</b>
The sounds seem distorted, especially when the Horn or bell is activated.	Loco-Sound volume is set too high. Turn the volume control knob on the bottom of the chassis counter-clockwise to reduce the volume.
No sound.	Volume is set too low, adjust volume control knob on the bottom of the chassis clockwise to increase the volume or check connector to speaker.
<b>Proto-Cast and-Dispatch</b>	<b>Remedy</b>
When I try to play music or my voice through my engine's speakers, there is popping and interference.	Clean the track with denatured alcohol, as described in the "Cleaning the Wheels, Tires, and Track" section of this book.
My Proto-Cast sounds play too quietly or unclearly.	Unplug the cable between the audio source and the remote lock-on. Re-plug it into the audio source first, then into the lock-on, pushing firmly to make sure it is fully installed.
When I try to play Proto-Cast, the engine's sounds keep breaking in on my recording.	Your recording may be playing too quietly to trigger the engine to stop playing its own sound set. Turn up the volume of the audio source you are using.
When I run two Loco-Sound engines on tracks near each other, the Proto-Cast and Dispatch sounds play from both engines, not just from the one connected to the audio source or microphone.	This is normal behavior. Because Loco-Sound uses radio waves to transmit the sound to the engine, other Loco-Sound engines in the same range will also pick up the sound. Try moving one of the sets.



# Compatibility

While this Ready-To-Run set is equipped with everything you need to operate it, the design allows flexibility. The train will operate on any traditional O-31 or larger O Gauge track system, including the RealTrax<sup>®</sup> included with this set or traditional tubular track. It is also compatible with most standard AC transformers, including the hobby transformer packaged with your set.

## Transformer Compatibility and Wiring Chart

Note that many of the operational commands described in these instructions require a bell button, so if you are using a transformer other than the one included in this set and your transformer does not have its own bell button, you should consider adding one to get the full benefit of the system.

Transformer Model	Center Rail	Outside Rail	Min/Max. Voltage	Power Rating	Transformer Type
MTHZ-500	Red Terminal	Black Terminal	0-18v	50-Watt	Electronic
MTHZ-750	Red Terminal	Black Terminal	0-21v	75-Watt	Electronic
MTHZ-4000	Red Terminal	Black Terminal	0-22v	390-Watt	Electronic
Lionel1032	U	A	5-16v	90-Watt	Standard
Lionel1032M	U	A	5-16v	90-Watt	Standard
Lionel1033	U	A	5-16v	90-Watt	Standard
Lionel1043	U	A	5-16v	90-Watt	Standard
Lionel1043M	U	A	5-16v	90-Watt	Standard
Lionel1044	U	A	5-16v	90-Watt	Standard
Lionel1053	U	A	8-17v	60-Watt	Standard
Lionel1063	U	A	8-17v	60-Watt	Standard
All-Trol	Left Terminal	Right Terminal	0-24v	300-Watt	Electronic
Dallee Hostler	Left Terminal	Right Terminal			Electronic
Lionel LW	A	U	8-18v	75-Watt	Standard
Lionel KW	A or B	U	6-20v	190-Watt	Standard
Lionel MW	Outside Track Terminal	Inside Track Terminal	5-16v	50V.A.	Electronic
Lionel RS-1	Red Terminal	Black Terminal	0-18v	50V.A.	Electronic
Lionel RW	U	A	9-19v	110-Watt	Standard
Lionel SW	U	A	Unknown	130-Watt	Standard
Lionel TW	U	A	8-18v	175-Watt	Standard
Lionel ZW	A, B, C or D	U	8-20v	275-Watt	Standard
Lionel Post-War Celebration Series ZW	A, B, C or D	Common	0-20v	135/190 Watt	Electronic

## 2-8-0 Steam Locomotive Engine Parts

NameandNumber	Part#
1.) Stanchion ( black) (plastic)(3.0mmlong)	FB-1200242
2.) Handrail(nickel)(boiler)	FB-1200099
3.) Bell(nickel)	FB-1200101
4.) Shell(black)(CNW)(#1761)	FB-1200239
5.) Lens(green)(marker)	FA-1230025
6.) Lens(clear)(headlight)	FA-1230022
7.) Numberboard(black)	FB-1200178
8.) Smokeunit (7.0x8.0x2.0x3.7mmbrasscup)(7.5mmlongposts) (Proto-Sound2.0®&LocoSound™)	AA-0000029
9.) Bulb(clear)(headlight) (6V)(smallglobe)(screwbase)	CA-0000038
10.) Bracket(black) (smokeunit/headlight)	IH-0000085
11.) Screw (4/40x6.0mm)( roundhead )	IA-0000003
12.) Crosshead(nickel) (38.8mmlong)	EC-1250016
13.) Driverod(nickel)	EC-1250015
14.) Driveblock(black)(4axle)	DF-1200018
15.) Bolt(nickel) ( hexhead5.0mm)(M3x9.5mmlong) (4.0x2.5mmshoulder)	IA-0000253
16.) Siderod(nickel) (116.0mmlong)(4holes)	EC-1250017
17.) Tractiontires	DE-0000023
18.) Insulator(black) (top)(square)(pick-up)	BD-0000026
19.) Screw(nickel) (M3x6.0mm)(roundhead)	IA-0000015
20.) Wirestrap(white) (metal)(tabbendsoverwires)	IH-0000103
21.) Tachboard ( no spacerbetweenboardandopticalsensor) ( hasatinyresistoronbacksideoftachboard)	AG-0000048
22.) Motor(RS-365SH) (8.0x21.0mm gearshaft)(13.0mmgearthreads) (9.0x30.0mmwhiteflywheelw/blackstripes) (tachboardmountingstrap)	BE-0000076
23.) Screw (6/32x8.0mm)(roundhead)	IA-0000050
24.) Motormount(black)	BI-0000034
25.) Screw(yellowZink) (M2.5x6.0mm)(roundheadw/lockwasher)	IA-0000089

26.) Wirenut(yellow)	BI-4500003
27.) PCboard(green) (w/10pinfemaleplug)	AG-0000039
28.) Drawbar(black) (67.5mm long )	FB-1200079
29.) Spring (6.5x10.0mm)(w/0.6mmthickwire)	IE-0000061
30.) Screw (4/40x6.0mm)(washerhead)	IA-0000028
31.) Nut(nickel)(2.5x5.0x10.0mm)	IC-0000005
32.) Insulator(black) (pick-up)(bottom)(flat)(square)	BD-0000024
33.) Pick-up (8.0x11.0mmroller)(24.0mmlong)	BD-0000050
34.) Bolt(nickel) (M3x9.5mmlong)(4.0x2.5mmshoulder) (5.0mmhexhead)	IA-0000253
35.) Truck(lead)(singleaxle)	DA-1230013
36.) E-clip(2.5x6.0x0.5mm)	IF-0000004
37.) Washer(3.0x7.0x0.4mm)	ID-0000028
38.) Spring (6.5x11.0mm)(w/0.4mmthickwire)	IE-0000007
39.) Pin (3.0x9.0mm)(flathead)(1e-clipgroove)	IG-0000007
40.) Pivotplate(nickel) (forleadtruck)	IH-0000021
41.) Bracket(black) (metal)(18.6x32.4x40.5mm)(Tshaped)	IH-0000211
42.) Ferritebead	AI-0000030
43.) Capacitor(blue)(.01uF) (16.0x2.0mm)( w/2wires)	AI-0000031
44.) Steamdome(black)	FB-1200247
45.) Sanddome(black)	FB-1200246
46.) Washer(black) (3.0x6.0x0.4mm)(fiber)	ID-0000040

# 2-8-0 Steam Locomotive Engine Parts

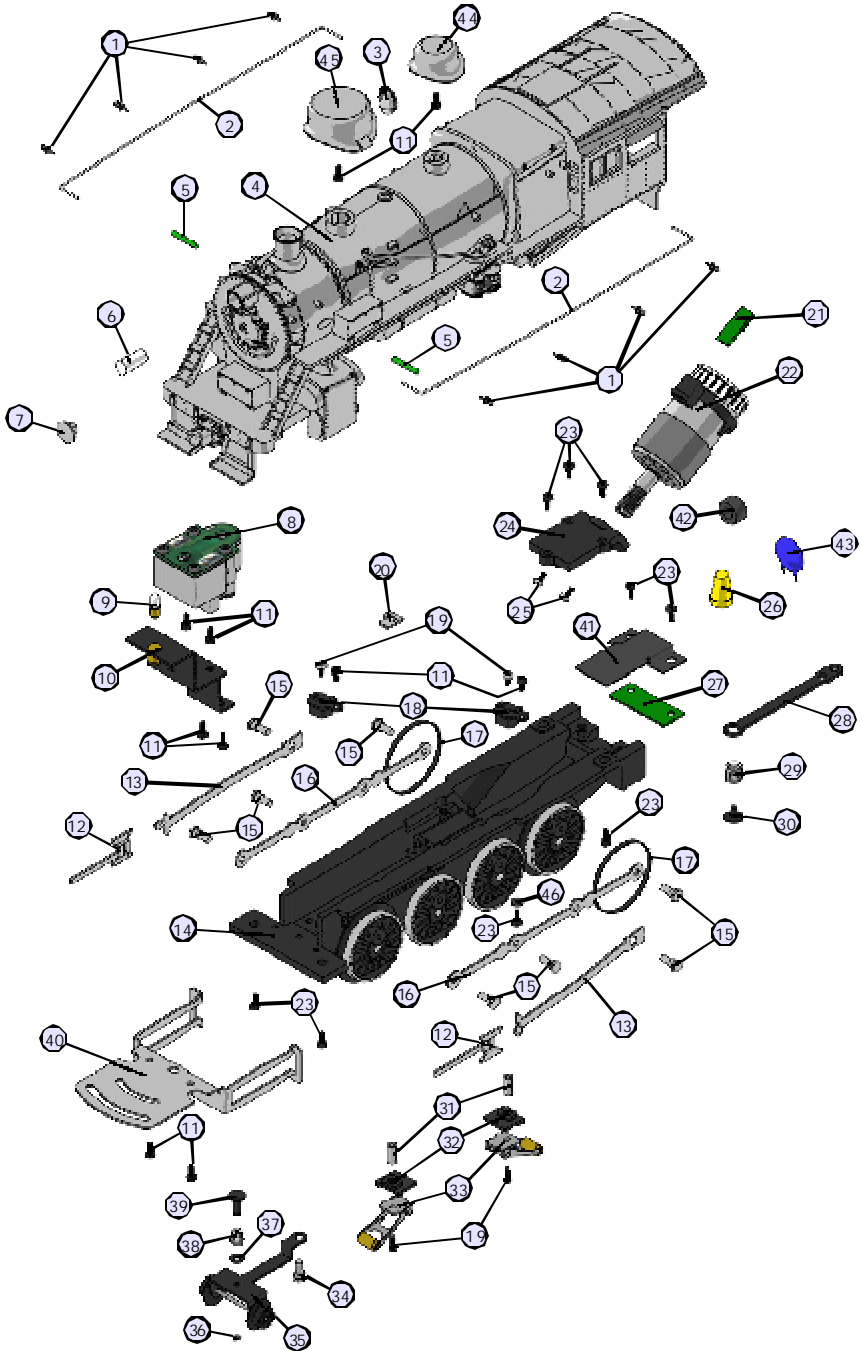

## 2-8-0 Steam Engine Tender Parts

NameandNumber	Part #
1.) Shell(black) (tender)(plastic)(CNW)(#1761)	GA-1200094
2.) Board (Loco-Sound™)(steam/turbine)	AE-0000003
3.) Screw (4/40x8.0mm)(roundhead)	IA-0000011
4.) Insulator(white) (washer)(3.0x6.0x3.0mm)(plastic)	ID-0000025
5.) Insulator(clear) (13.0x19.0x0.1mm)(singlehole)	ID-0000024
6.) Screw (M3x4.0mm)(roundhead)	IA-0000010
7.) Screw (M3x6.0mm)(roundhead)	IA-0000016
8.) Wirenut(yellow)	BI-4500003
9.) Speakercone(black) (44.0x48.3x37.0mm)(plastic)(2screwwholetabs)	BF-0000020
10.) Speaker (Cuistack)(GF0501,8ohms,0.25watt)	BF-0000015
11.) Wireharness(black)	BC-1200103
12.) Screw (M2x4.0mm)(roundhead)	IA-0000058
13.) Switch(small)	BB-0000009
14.) Screw (4/40x6.0mm)(roundhead)	IA-0000003
15.) Bracket(Aluminum) ( forLoco-Sound™board) (14.0x76.0x24.7mm)(5.0mmstep)	IH-0000212
16.) Screw (M3x8.0mm)(roundhead)	IA-0000035
17.) Volumepot ( small) (bluew/greenboard)	BI-0000040
18.) Spacer(black) (3.0x6.0x4.0mm)(plastic)	ID-0000071
19.) Chassis(black) (58.0x175.0mm)(hasnewholeforbatteryjack)	GB-1200047
20.) Screw (M3x16.0mm)(washerhead)(self-drillingthreads )	IA-0000025
21.) T-bar	IG-0000001
22.) Coupler(black) (mechanical)(51.5mmlong)	DD-0000039
23.) Armature(black) (45.0mmlong)	DD-0000040
24.) Spring (6.5x11.0mm)(w/0.4mmthickwire)	IE-0000007

25.) Washer(black)(plastic) (4.6x8.6x2.0mm)(inside7.0x1.0mm)(cupshaped)	ID-0000060
26.) E-clip(3.0x8.0x0.5mm)	IF-0000002
27.) Truck(black) (tender)(2 axle)	DA-1250012
28.) Screw (6/32x6.0mm)(washerhead)	IA-0000214
29.) Gasket(black) (speackerring)(43.8x49.8x3.0mm)(foam)	IB-0000009
NS.) Wireharness (12pinblackmaleplug)	BC-1200104

# 2-8-0 Steam Engine Tender Parts

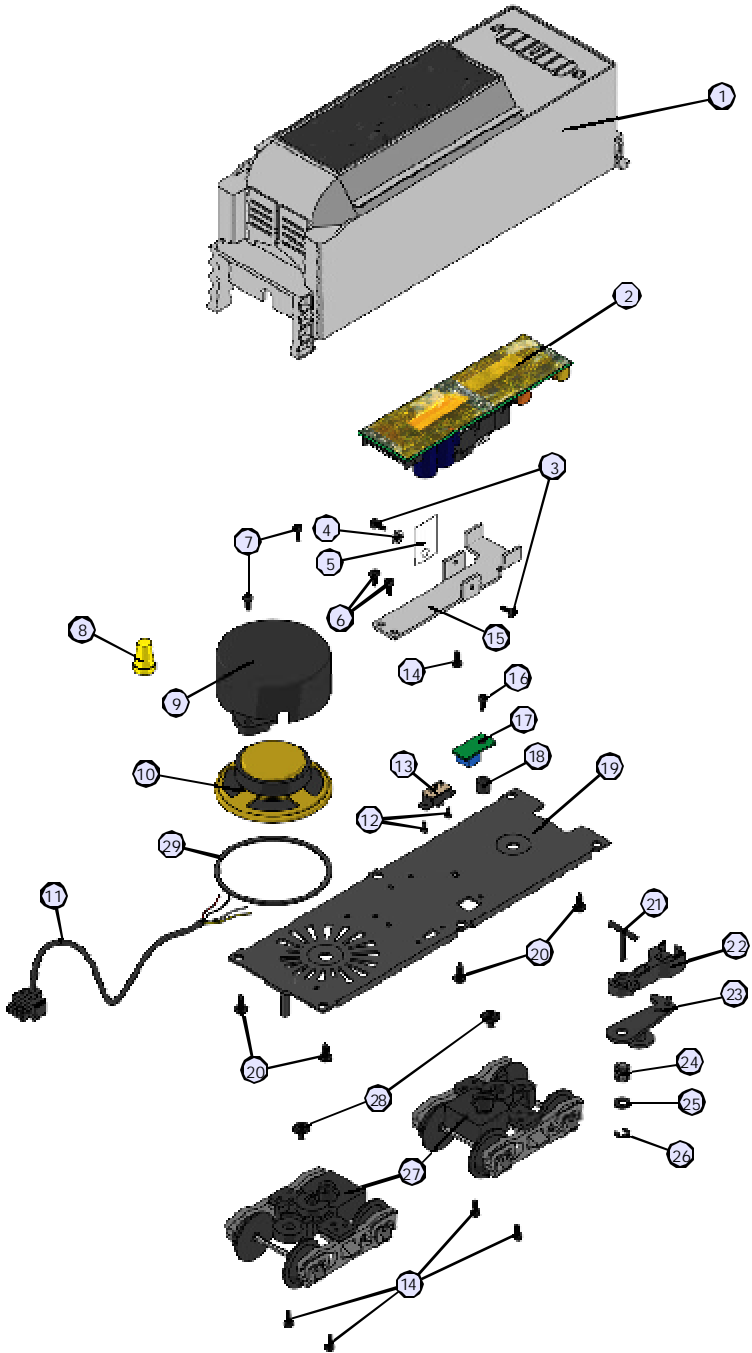

# Service & Warranty Information

## How to Get Service Under the Terms of the Limited One-Year Warranty

For warranty repair, follow the instructions below to obtain warranty service.

- First, e-mail, write, call or fax an Authorized M.T.H. Service Center in your area or M.T.H. Electric Trains to obtain Repair Authorization. You can find the list of Authorized Service Centers on the M.T.H. website, [www.mth-railking.com](http://www.mth-railking.com). Otherwise, contact M.T.H. (e-mail: [service@mth-railking.com](mailto:service@mth-railking.com); 7020 Columbia Gateway Drive, Columbia, MD 21046; tel: 410-381-2580; fax: 410-423-0009), stating when the item was purchased and describing the problem. If you contact M.T.H., you will be given a return authorization number to assure that your merchandise will be properly handled upon its receipt.
- **CAUTION:** Make sure the product is packed in its original factory packaging including its foam and plastic wrapping material so as to prevent damage to the merchandise. The shipment must be prepaid and we recommend that it be insured. ***A cover letter including your name, address, daytime phone number, e-mail address (if available), Return Authorization number, a copy of your sales receipt and a full description of the problem must be included to facilitate the repairs. Please include the description regardless of whether you discussed the problem with a service technician when contacting the Service Center M.T.H. for your Return Authorization.***
- Please make sure you have followed the instructions carefully before returning any merchandise for service.

## Limited One-Year Warranty

All M.T.H. products purchased from an Authorized M.T.H. Train Merchant are covered by this warranty.

See our website at [www.mth-railking.com](http://www.mth-railking.com) or call 1-888-640-3700 to identify an Authorized M.T.H. Train Merchant near you.

M.T.H. products are warranted for one year from the date of purchase against defects in material or workmanship, excluding light bulbs, pick-up rollers and traction tires. We will repair or replace (at our option) the defective part without charge for the parts or labor, if the item is returned to an Authorized M.T.H. Service Center or M.T.H. Electric Trains within one year of the original date of purchase. This warranty does not cover damages caused by improper care, handling, or use. Transportation costs incurred by the customer are not covered under this warranty.

Items sent for repair must be accompanied by a return authorization number, a description of the problem, and **acopy of the original sales receipt from an Authorized M.T.H. Train Merchant**, which gives the date of purchase. If you are sending the item to M.T.H., call 410-381-2580, fax 410-423-0009, or e-mail the Service Department at [service@mth-railking.com](mailto:service@mth-railking.com) to obtain a return authorization number. If you are sending this product to an Authorized Service Center, contact that Center for their return authorization.

This warranty gives you specific legal rights, and you may have other rights that vary from state to state.

Service Department  
M.T.H. Electric Trains  
7020 Columbia Gateway Drive  
Columbia, Maryland 21046-1532

