



# 4-6-2 Imperial P47 Pacific Steam Engine

OPERATOR'S MANUAL



## Compatibility

This engine will operate on any traditional O-31 Gauge track system, including M.T.H.'s RealTrax® or ScaleTrax™ or traditional tubular track. It is also compatible with most standard AC transformers. See pages 47 and 48 for a complete list of compatible transformers, power packs, and wiring instructions.



PFA  
Passenger/Freight  
Announcements

PLEASE READ BEFORE USE AND SAVE  
[www.mthtrains.com](http://www.mthtrains.com)

# Table of Contents

|  |           |
|--|-----------|
| Before You Begin .....   | 3         |
| Set Up Checklist .....   | 3         |
| Getting Started .....  | 3         |
| Lubrication .....  | 3         |
| Priming the Smoke Unit .....   | 4         |
| Placing Engine on Track .....  | 5         |
| <b>PS 3.0 Enhancements .....</b>   | <b>7</b>  |
| Conventional AC/DC Start-up/Shut-down .....                              | 7         |
| Programming Track (for DCC operation) .....                              | 7         |
| Activating DCC Mode .....  | 8         |
| Loading Engine Firmware .....  | 8         |
| LED Lighting .....   | 8         |
| <b>Modes of Operation .....</b>  | <b>9</b>  |
| <b>Conventional AC Operation .....</b>                                   | <b>9</b>  |
| Proto-Sound® 3.0 Conventional AC Operating Instructions .....            | 10        |
| Activating Proto-Sound® 3.0 Conventional AC Mode Features .....          | 10        |
| Manual Volume Control .....  | 11        |
| Marker Lights (if equipped) .....  | 11        |
| Passenger/Freight Announcements (PFA) .....                              | 12        |
| Proto-Coupler™ Operation .....   | 13        |
| Speed Control .....  | 14        |
| Locking Locomotive Into A Direction .....                                | 14        |
| Reset To Factory Default .....   | 15        |
| Automatic Sound Effects .....  | 15        |
| <b>Conventional DC Operation .....</b>                                   | <b>16</b> |
| <b>DCS - Digital Command System .....</b>                                | <b>16</b> |
| <b>DCC - Digital Command Control .....</b>                               | <b>17</b> |
| Basic DCC Operation .....  | 17        |
| Start up/Shut Down .....   | 17        |
| Sounds .....   | 18        |
| Lights .....   | 18        |
| Master Volume .....  | 19        |
| Couplers .....   | 19        |
| Forward/Reverse Signal .....   | 19        |
| Crossing Signal .....  | 19        |
| Smoke (if equipped) .....  | 20        |
| Engine Sounds .....  | 20        |
| Additional F Functions .....   | 20        |
| Function Chart .....   | 22        |
| CV29 .....   | 23        |
| Long and Short Addressing .....  | 23        |
| Feature/Factory Resetting .....  | 24        |
| Lost or Unknown Engine Address and the 55-55-55 Address Reset .....      | 25        |
| <b>M.T.H. Proto-Sound® 3.0 Expanded DCC Functionality .....</b>          | <b>26</b> |
| Advanced DCC Operation .....   | 26        |
| Configuration Variables .....  | 26        |
| Advanced Consisting .....  | 30        |
| Programming Track .....  | 33        |
| <b>Maintenance .....</b>   | <b>35</b> |
| Lubricating and Greasing Instructions .....                              | 35        |
| Cleaning The Wheels, Tires and Track .....                               | 36        |
| Traction Tire Replacement Instructions .....                             | 37        |
| Smoke Unit Operation .....   | 37        |
| Headlight Replacement .....  | 38        |
| <b>Troubleshooting Proto-Sound® 3.0 Problems .....</b>                   | <b>39</b> |
| <b>Transformer Compatibility and Wiring Chart .....</b>                  | <b>47</b> |
| <b>DC Power Supply Chart .....</b>                                       | <b>48</b> |
| <b>Additional Features Accessible Of DCS Remote Control System .....</b> | <b>49</b> |
| <b>Service &amp; Warranty Information .....</b>                          | <b>50</b> |

## CAUTION: ELECTRICALLY OPERATED PRODUCT:

Recommended for Ages 14 and up. Not recommended for children under 14 years of age without adult supervision. As with all electric products, precautions should be observed during handling and use to prevent electric shock.

**WARNING:** When using electrical products, basic safety precautions should be observed, including the following:

- Read this manual thoroughly before using this device.
- M.T.H. recommends that all users and persons supervising use examine the hobby transformer and other electronic equipment periodically for conditions that may result in the risk of fire, electric shock, or injury to persons, such as damage to the primary cord, plug blades, housing, output jacks or other parts. In the event such conditions exist, the train set should not be used until properly repaired.
- Do not operate your layout unattended. Obstructed accessories or stalled trains may overheat, resulting in damage to your layout.
- This train set is intended for indoor use. Do not use if water is present. Serious injury or fatality may result.
- Do not operate the hobby transformer with damaged cord, plug, switches, buttons or case.

This product may be protected by one or more of the following patents: 6,019,289; 6,280,278; 6,281,606; 6,291,263; 6,457,681; 6,491,263; 6,604,641; 6,619,594; 6,624,537; 6,655,640.

Rev: \_RK 4-6-2 Imperial P47 Ps3 2018 5/29/18

# Before You Begin

By visiting the M.T.H. website, [www.mthtrains.com](http://www.mthtrains.com), you will be able to view any additional manual updates that affect your engine. Enter the MTH Item number of the engine you want to check and select the manual icon to download or view it. You will need Adobe Acrobat Reader to view the manual.

**You can obtain replacement parts and replacement instructions from the M.T.H. Parts Department.** Order online: [www.mthtrains.com](http://www.mthtrains.com), E-mail: [parts@mth-railking.com](mailto:parts@mth-railking.com), Fax: 410-423-0009, Phone: 410-381-2580, Mail: 7020 Columbia Gateway Drive, Columbia MD 21046-1532

## Set Up Checklist

- Lubricate Engine and Prime Smoke Unit
- Read all General Maintenance Instructions
- Apply power to run as described in the Modes of Operation section

## Getting Started

### Lubrication

You should lubricate the engine to prevent it from squeaking. Use light household oil and follow the lubrication points marked “L” below. Do not over-oil. Use only a drop on each pivot point.

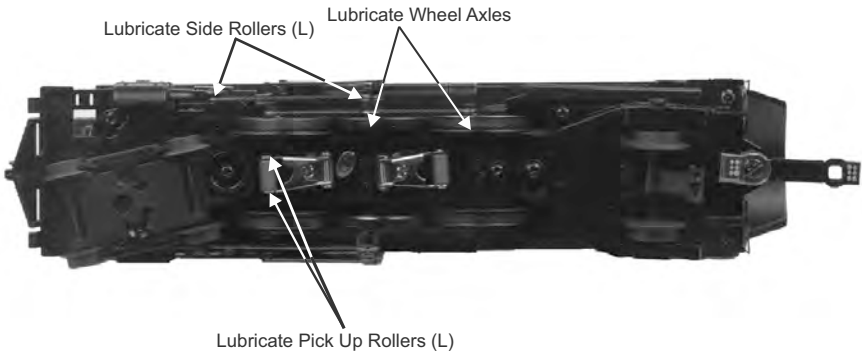

*Figure: Lubricating the Locomotive*

# Priming the Smoke Unit

When preparing to run this engine, add 15-20 drops of smoke fluid through the smokestack (shown below). We recommend M.T.H. ProtoSmoke™ fluid. Do not overfill the unit or the fluid may leak out and coat the interior engine components.

If you choose not to add smoke fluid (or have already added fluid but choose to run smoke-free), turn off the smoke unit by turning the smoke unit control to the “OFF” position, fully Counter Clockwise position. **Failure either to add fluid to the smoke unit or to turn it off may damage the smoke unit heating element and/or wicking material.** See the "ProtoSmoke Unit Operation" section of this book for more information on smoke unit maintenance.

 **Running the engine without a primed smoke unit may cause damage**



*Figure: Adding Smoke Fluid*

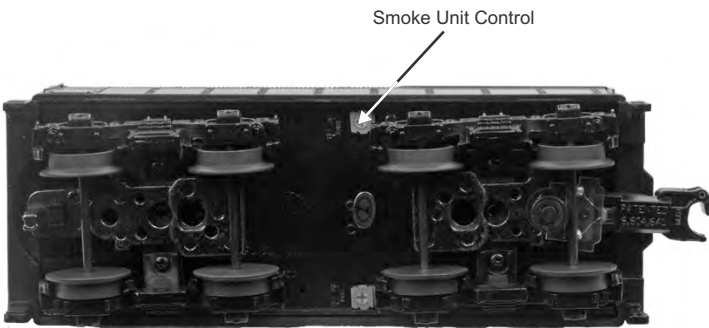

*Figure: Smoke Volume*

## Placing The Engine On The Track

Your MTH steam engine is equipped with a tetherless drawbar. There is no unsightly cable or box showing between the engine and the tender to detract from the appearance of the model. The electrical connections pass through conductors in the drawbar, so it is important that the connector be properly inserted. The connector is fixed to the rear end of the drawbar. The mating connector is attached to a swivel connection on the front of the tender frame. The drawbar is connected to the engine chassis with a screw and should not need any attention.

In order to mate the connectors of the drawbar and the tender, place the engine and the tender on the track. Position the tender over the drawbar connector and insert the drawbar pin on the swivel connector into the hole in the drawbar.

Grasp the tender with both hands as shown below and place a finger on each side of the drawbar near the connector. Now using your fingers, push the connectors together. The connector will make a slight click when it is properly seated. At this point you are ready to begin operating your engine.



*Figure: Connecting Locomotive to Tender*



*Figure: Engine and Tender*

To disconnect the engine and tender apply downward pressure near the tender until the connectors separate. The drawbar is able to withstand a 90 degree twist such as might be experienced in a derailment where the engine or the tender would turn over and the other unit would remain upright.

If the drawbar is not properly connected your engine may exhibit erratic or no operation. If this happens turn off the track power and make sure that the drawbar connectors are properly seated. Then reapply power to the track and continue operation.

## Plastic Drawbar Holder

In some rare cases the connector may disconnect from the drawbar when running the engine up a trestle with an extreme incline. If you are having any problems we have included a holder that can be attached to the bottom of the drawbar. Please see the photos below.



The side of the holder that has the white dot on it needs to face upward when it is applied to the drawbar.

*Figure: Plastic Holder*

Tilt the tender slightly to apply the holder to the drawbar.

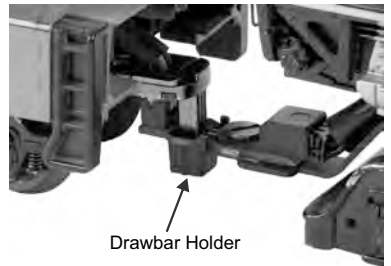

*Figure: Attaching the Plastic Drawbar Holder*

*\*The figures seen here are generic interpretations. Details may be different for your model.*

# PS 3.0 Enhancements

Here are some of the exciting changes incorporated into your new MTH Proto-Sound® 3.0 Locomotives. More advanced features such as Custom Speed Tables and Advanced Consisting can be found in the DCC section of this manual.

There are 4 options for operating your MTH Proto-Sound® 3.0-equipped engine:

- Conventional AC
- Conventional DC
- DCS - MTH Digital Command System
- DCC - Digital Command Control (requires modification)

When the locomotive is placed on the track and power is applied to the track the locomotive will detect the type of control system being used and respond accordingly.

**NOTE: If you wish to use DCC as a control system, follow the activation instructions in the Activating DCC Mode section later in this manual.**

## Conventional (Analog) AC/DC Start-up/Shut-down

Your new MTH PS3.0-equipped locomotive no longer has batteries. It uses Super Capacitors to hold the engine board alive for a short time when you shut off or interrupt track power. Because of this, when you first apply track power to your PS3.0-equipped O Gauge engine, you will notice the headlight comes on but nothing else. This is perfectly normal. The capacitors are charging up during this time. The wait time depends upon how long it's been since you last applied power to the engine. Typically it will take 1-15 seconds to fully charge. **NOTE: The 1-15 second charging wait time ONLY applies to conventional AC track power.**

Once the headlight shuts off, the engine will play its start-up sounds and all the lights will come back on, simultaneously. Smoke too if you have it turned on.

The capacitors hold enough charge to play the full shut-down sounds. Also, the capacitors allow you to operate your engine in conventional mode just like you would any other conventionally-controlled engine. Finally, because there are no batteries, you will notice there is no external charging jack on the engine or tender.

## Programming Track (for DCC operation)

Your MTH Proto-Sound 3.0-equipped locomotive does not program well on Programming tracks due to the inclusion of super capacitors utilized in the locomotive's electronic package. The super capacitors provide backup power to the electronics, allowing the locomotive to better negotiate track sections suffering from poor electrical conductivity. This ensures that sounds continue to play, the locomotive continues to move forward and lighting remains lit. During power shutdowns, the super capacitors provide power to allow the locomotive shutdown sounds to continue playing through their conclusion. Unfortunately, the super capacitors require that operators ONLY program engine CV's using Programming on the Main (PoM).

## Activating DCC Mode

Even though your locomotive is equipped with a DCC decoder, you will notice that there is no switch to select it. We found that when the switch was present, it was confusing to those who are not familiar with DCC operations. In order to operate in DCC you will need to remove the tender body and then carefully remove the jumper block (be careful not to damage the Signal Transformer) on the Printed Circuit Board as shown here.

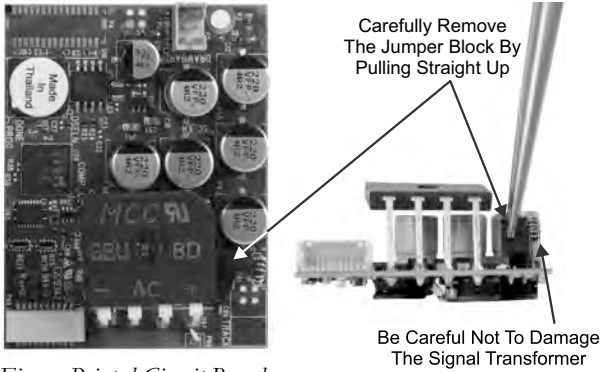

*Figure: Printed Circuit Board*

When the jumper block is installed, the engine will respond to DCS signals. When the jumper block is removed, the engine will respond to DCC signals. After removing the jumper block keep it in a safe place in case you decide to operate with DCS in the future.

### CAUTION:

- Do not apply DCS signals and DCC signals to the same track simultaneously. The signals are not compatible, mixing the DCS and DCC signals will damage the DCS TIU unit.
- Do not operate the engine with a DCC without removing the jumper block. Damage to the PS 3.0 board will occur.
- If attempting to control the engine with DCS when the jumper block is removed, the engine will not respond to commands.

## Loading Engine Firmware

Your MTH PS3.0-equipped locomotive affords you the ability to load Engine firmware. Loader version 2.30 or later will allow you to do this. Please refer to the Loader program's instructions for more details. So, as MTH releases new features or updates you will be able to take full advantage without having to ship your favorite engine anywhere. All new updates are available on our website. MTH will make announcements as they are available. Not all updates will apply to all engines. **NOTE: Requires a TIU w/version 4.20 or later firmware, and requires Consumer Loader version 2.30 or later.**

## LED Lighting

Gone are the incandescent bulbs. Your new PS3.0-equipped engine has LED lighting. MTH uses various colored LEDs to simulate the correct lighting on your engines from the warm, yellow-orange colored light coming out of an old lantern on your favorite steam engine to the high-intensity halogen lamp on the latest modern diesels, LED's allow for various, correct colors. Also, they require less power and do not emit as much heat as incandescent bulbs.



# Modes of Operation

The following pages have detailed descriptions of the 4 different modes of operation:

- Conventional AC
- Conventional DC
- DCS - MTH Digital Command System
- DCC - Digital Command Control (requires modification)

## Conventional AC Operation

When using conventional AC power, the engine will respond to changes in track voltage. An increase in track voltage will increase the locomotive speed and a reduction in track voltage will reduce the engine speed.

A short interruption (approximately 1 to 2 seconds) in the track voltage will cause the engine to cycle in the sequence for each track voltage interruption (neutral – forward – neutral – reverse) When power is first applied to the track, the locomotive will be silent for 1-20 seconds and the headlight will be on, indicating the super capacitors are charging (The super capacitors provide power to the sound system during direction changes or intermittent drops in track power due to dirty track or on switches, when operating in conventional mode). When the super capacitors are charged, all the lights will come on and the engine sounds will start up. There should be no movement, as the engine is in neutral. Causing a short interruption of track power by using the direction button on the transformer, or by bringing the throttle to 0 volts and back again, will change the sequence to the forward state. Then increasing the throttle will begin to move the engine forward, and speed will increase as the throttle is advanced.

If there is another interruption in track power the sequence will change to the neutral position again. The engine will remain in the neutral state until there is another interruption in track power. The next interruption in track power will move the sequence to the reverse state. The engine will now move in the reverse direction. If the power interruption was accomplished by using the direction button and the throttle position was not changed, the engine will run in the reverse direction at the same speed that it was traveling in the forward position.

Subsequent interruptions in track power of 1-2 seconds will continue the sequence rotation. If you happen to interrupt track power for longer than about 2 seconds, the engine will begin its shut down sounds. If this occurs you can cycle the direction sequence again to get back to the direction you wish to move and once the engine starts moving its shut down sounds will stop playing.

In conventional AC operation the whistle sound, the bell sound, PFA sounds and other operational functions can be accessed if your transformer has a horn/whistle button and a bell button. By using combinations of button presses, different commands besides blowing the whistle and ringing the bell can be initiated.

# Proto-Sound<sup>®</sup> 3.0 Conventional AC Operating Instructions

## Activating Proto-Sound<sup>®</sup> 3.0 Conventional AC Mode Features

**Throttle:** To increase or decrease track voltage, and therefore train speed, turn the throttle control knob. Turning clockwise will increase voltage and speed, while turning counterclockwise will decrease voltage and speed. The engine will maintain the speed you set after you release the throttle until you turn it again to change the voltage and speed.

**Bell:** To sound the bell, in an engine equipped with a bell firmly press and release the Bell button. To turn the bell off, press and release the Bell button again. The bell will continue to ring from the time you turn it on until you press and release the button again to turn it off.

**Horn/Whistle:** To sound the whistle, firmly press the Horn/Whistle button. The whistle will sound for as long as you continue to depress the button. It will stop when you release the button.

**Direction:** Your train is programmed to start in neutral. The train will always cycle neutral-forward-neutral-reverse with each press and release of the direction button. The engine is programmed to restart in neutral each time the track voltage is turned off for 25 seconds or more.

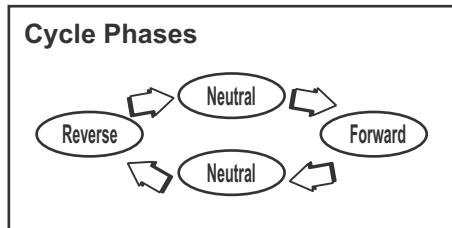

## Manual Volume Control

To adjust the volume of all sounds made by this engine, turn the manual volume control clockwise to increase the volume and counterclockwise to reduce the volume. Turning the manual volume control completely counterclockwise will turn off all of the engine sounds and announcements.

Manual Volume Control

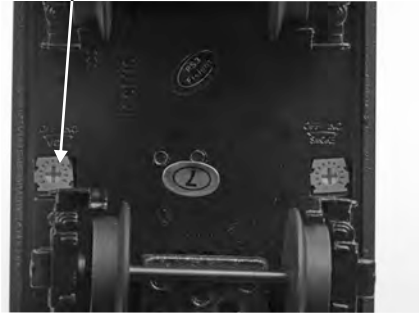

Figure: Manual Volume Control

Proto-Sound® 3.0 features are activated by sequences of Bell and Horn button pushes described below. Please read the full descriptions of each feature before using it. To use these buttons to activate features rather than to blow the horn or ring the bell, you should tap the buttons very quickly with a 1/2-second pause between button presses. You may need to practice your timing to make this work smoothly.

| Timing Chart                     |                   |                                  |                   |                                  |
|----------------------------------|-------------------|----------------------------------|-------------------|----------------------------------|
| Press<br>Horn<br>Short &<br>Firm | 1/2 Sec.<br>Pause | Press<br>Bell<br>Short &<br>Firm | 1/2 Sec.<br>Pause | Press<br>Bell<br>Short &<br>Firm |
| Total Time Lapse: 1 1/2 Seconds  |                   |                                  |                   |                                  |

| Feature to Be Activated               | Button Code                                 |
|---------------------------------------|---|
| Marker Lights*                        | 1 Bell, 1 Horn/Whistles                     |
| PFA (Passenger/Freight Announcements) | 1 Bell, 2 Horn/Whistles                     |
| Fire the Rear Coupler                 | 1 Bell, 3 Horn/Whistles                     |
| Fire the Front Coupler                | 1 Bell, 4 Horn/Whistles                     |
| Speed Control On/Off                  | 1 Horn/Whistle, 2 Bells (from Neutral only) |
| Lock into a Direction                 | 1 Horn/Whistle, 3 Bells                     |
| Beacon Light (On/Off)*                | 1 Horn/Whistle, 4 Bells                     |
| Reset to Factory Defaults             | 1 Horn/Whistle, 5 Bells (from Neutral only) |

\*Only applicable to engines equipped with beacon and/or marker lights. Beacon Lights are also configured to control Wrong Line, Alternate Country and other lighting setups typically found on European models. Marker lights are also used as Train/No-Train lighting in European models.

## Marker Lights (On/Off) (if equipped)

By default your Marker Lights are set to ON. To toggle the Marker Lights, perform the following sequence on your AC transformer:



## Passenger/Freight Announcements (PFA)

Your engine is equipped with a sound package of either passenger station announcements or freight yard sounds that you can play when you pull into a station or a yard. Each sequence described below will play as long as it is left on, randomly generating sounds, but be sure to allow approximately 30 seconds between the button pushes described below to allow the PFA sufficient time to run through each sequence.

- To cue the sound system to play the PFA, quickly but firmly tap the Bell button once followed by 2 quick taps of the Horn button while the engine is moving. Tap the buttons quickly but allow approximately 1/2 second between each press.
- Press the Direction button once to stop the engine. This will trigger the first sequence of PFA. The reverse unit is temporarily disabled so that the train will not move as you use the Direction button to trigger the sounds. Proto-Sound 3.0 has disabled operator control over the Horn and Bell buttons until the full PFA sequence is complete.
- After waiting about 30 seconds for that sequence to run, press the Direction button again to trigger the second sequence of PFA.
- After about 30 seconds, press the Direction button again to trigger the third PFA sequence.
- Again, after allowing about 30 seconds for that sequence to run, press the Direction button one more time to trigger the fourth and final PFA sequence. The PFA will continue and within a few seconds the bell will begin ringing, then the engine will begin moving at the current throttle setting, in the same direction it was traveling when you began the sequence. Once the bell turns off, the operator regains control of the transformer's bell and Horn buttons and can ring the bell or blow the Horn as usual.

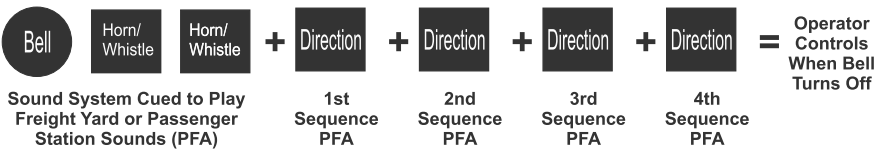

## Tips on Using PFA

- You can terminate PFA at any time by turning off power to the track for 15 seconds.
- You do not have to be in Forward to use PFA. At the conclusion of the full sequence, the train will pull away from the station or yard in whatever direction you were going when you activated the feature.
- You can use PFA even if you are double-heading with another engine. If the second engine is not equipped with Proto-Sound<sup>®</sup> 3.0, you must remember not to leave the throttle at a high voltage level once you have stopped the engine to run the PFA. Otherwise, the engine without PFA will begin vibrating on the track as its motors strain to move the train, since they cannot be automatically disabled during the PFA cycle (or if an original Proto-Sound<sup>®</sup> engine, PFA are triggered differently and that engine's motor-disable feature will not be active when you run PFA in Proto-Sound<sup>®</sup> 3.0).
- PFA can be triggered from Neutral. It will operate the same as if triggered while in motion except that, at the conclusion of the PFA, the engine will depart in the next direction of travel, as opposed to the direction it was traveling before entering Neutral.

## Proto-Coupler<sup>™</sup> Operation

This locomotive is equipped with one or more coil-wound Proto-Couplers for remote uncoupling action. Because Proto-Couplers are controlled through the Proto-Sound<sup>®</sup> 3.0 microprocessor, they do not require an uncoupling track section or modification to your layout to function. You can fire a coupler from neutral or while in motion. Use the code shown below to fire the coupler(s).

### Rear Coupler

To fire the rear coupler, quickly tap the Bell button once followed by three quick taps of the Horn button, allowing approximately ½ second to lapse between each quick button press. The sound of the liftbar and air line depletion will play, and the knuckle will be released.

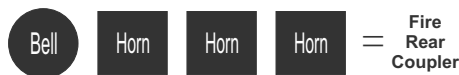

### Front Coupler

To fire the front coupler (if your engine has one), quickly tap the Bell button once followed by four quick taps of the Horn button, allowing approximately ½ second to lapse between each quick button press. The sound of the liftbar and air line depletion will play, and the knuckle will be released.



## Speed Control

M.T.H. engines equipped with Proto-Sound® 3.0 have speed control capabilities that allow the engine to maintain a constant speed up and down grades and around curves, much like an automobile cruise control. You can add or drop cars on the run, and the engine will maintain the speed you set.

While the engine is programmed to start with the speed control feature activated, you can opt to turn it off. This means the engine's speed will fall as it labors up a hill and increase as it travels downward. It is also affected by the addition or releasing of cars while on the run. Because the engine will run more slowly at a given throttle voltage when speed control is on than when it is off, you should adjust the throttle to a lower power level for operation with speed control off to avoid high-speed derailments. When speed control is off, the volume will drop to allow for better low voltage operation.

**To turn speed control on and off**, put the engine in neutral, then quickly tap the transformer's Horn button one time then quickly tap the Bell button two times, allowing approximately ½ second to lapse between each quick button press. Two horn blasts will indicate that the engine has made the change. Repeat the 1 horn, 2 bells code to return it to the other condition. You will want to do this during the initial neutral upon start-up if you ever couple this engine to another engine that is not equipped with speed control to avoid damaging the motors in either engine. Each time you shut down the engine completely, it will automatically turn speed control on.



Place  
Engine into  
Neutral

Horn

Bell

Bell

=

**Speed Control**  
**Two Horn Blasts**  
(indicates change is made)  
**Repeat to Return**  
**to Normal Condition**

## Locking Locomotive Into A Direction

You can lock your engine into a direction (forward, neutral, or reverse) so that it will not change directions. To do this, put the engine into the direction you want (or into neutral to lock it into neutral), run it at a very slow crawl (as slowly as it will move without halting), and quickly but firmly tap the Horn button once followed by three quick taps of the Bell button, allowing approximately ½ second to lapse between each quick button press. Two horn blasts will indicate that the engine has made the change. The engine will not change direction (including going into neutral) until you repeat the 1 horn, 3 bells code to return the engine to its normal condition, even if the engine is kept without power for extended periods of time.

Place  
Engine into  
Desired  
Direction

Horn

Bell

Bell

Bell

=

**Direction Lock**  
**Two Horn Blasts**  
(indicates change is made)  
**Repeat to Return**  
**to Normal Condition**

## Reset to Factory Default

To override the settings you currently have assigned to the engine and reset it to its factory defaults, while in Neutral tap the Horn button quickly once, followed by five quick taps of the Bell button, allowing approximately ½ second to lapse between each quick button press. Two horn blasts will indicate that the engine has made the change.



## Automatic Sound Effects

Certain Proto-Sound® 3.0 sound effects automatically play in programmed conventional mode conditions:

- Squealing Brakes play any time the engine's speed decreases rapidly.
- Cab Chatter plays at random intervals when the engine idles in neutral.
- Engine Start-up and Shut-down sounds play when the engine is initially powered on or is powered off for five seconds or more.

# Conventional DC Operation

Your MTH locomotive will operate on conventional DC track voltage also. However, functions such as sounding the horn, ringing the bell and the PFA sounds cannot be initiated in conventional DC. Only the engine sounds, smoke, squealing brakes and idle sounds will function.

Operation of your MTH Proto-Sound® 3.0 engine in conventional DC is very similar to operating a conventional AC engine. As you increase track voltage, engine speed increases.

As the track voltage is decreased, engine speed is decreased. When track voltage polarity is reversed using the polarity or direction switch on the power pack, the engine will run in the opposite direction. The electronics in your MTH Proto-Sound® 3.0 locomotive are designed to slowly change direction without a need to change the throttle, if you so desire.

Just change the polarity switch on your DC power pack and the engine will gradually come to a stop and then automatically begin traveling in the opposite direction. The speed will build up to the same speed that the engine was going in the previous direction. When power is first applied to the locomotive, the engine's sounds will start up when the track voltage reaches about 8 VDC. To get your locomotive moving, after the startup sounds have finished and the locomotive is idling, slowly increase the track voltage until the locomotive is traveling at the desired speed.

**NOTE:** If you apply more than 9.0VDC to the engine at start-up the engine will not move. This is normal. We refer to this as “Anti-Jackrabbit” and this feature prevents your model from taking off at high track voltages. Simply lower the track voltage down below 9.0VDC and then back up to get your engine moving. This applies only when you start up your engine.

# DCS - Digital Command System

While the acronyms are close, this is where the similarity ends between DCC and DCS. Yes they are both digital control systems. However, M.T.H. DCS is not DCC. There are several proprietary versions of DCC on the market, but DCS is not one of them. M.T.H.'s DCS System is a proven technology in the O Gauge, One Gauge, and HO Gauge markets. First the power signal in DCS is not the command signal. Next DCS employs a fully functional bi-directional communication scheme opening a vast range of advanced features and yet so simple and intuitive that you can enjoy them. No programming tracks, bits and bytes, or conversion of binary to hexadecimal numbers here. To add an engine in DCS, press “ADD ENGINE”. After that, if you want to start your engine just press “START UP” or to turn the smoke unit on or off, just press “SMOKE”. No combination of letters or numbers to remember.

Additional details can be found in the DCS manual that accompanies your DCS system or on the MTH Web site, [www.mthtrains.com](http://www.mthtrains.com) With DCS, you can have a whole fleet of MTH PS 3.0 engines on the rails and they will remain shut down until you command them to start up.



# DCC - Digital Command Control

(see the **Activating DCC** section for activation instructions)

DCC is a popular digital command scheme wherein the track power is also a digital control signal. That is, using a DCC controller, you can communicate with multiple engines and have all of them moving at different speeds and in varying directions on the same track at the same time. The power/command signal remains constant and engines are commanded to perform as desired. Your MTH PS3.0-equipped engine has the ability to decode and respond to these DCC commands. This allows you to mix and match MTH PS3-equipped engines as well as operate them with any other manufacturer's DCC-decoder equipped engine. The best part about your MTH PS3.0-equipped engine is that the decoder is built right in. No need to remove the hood and install speakers or boards. It's all done for you at the factory. Each PS3.0-equipped engine has a full complement of lights, sounds, smoke (if equipped). Just set the model on the rails, apply DCC power and hit F3 on your DCC handheld controller and you're off and running.

## Basic DCC Operation

Your MTH PS3.0-equipped engine takes full advantage of DCC's capabilities. Below are the basic commands you'll want to know to get started running quickly. Please refer to the Advanced DCC Operation section of the manual if you want to dig into the full capability of DCC.

Each engine type may have a slightly different F Function list. This depends upon whether it's steam, diesel, or electric and whether it has smoke or not. Please refer to the table of Default CV Values for your particular engine's F Functions.

A note about enabling/disabling F Functions in DCC - Depending upon the DCC system you have you may need to toggle a particular F Function on then off to actually get it to enable. Some DCC systems do this for you automatically and others allow you to set particular F Function buttons to either be set for momentary or toggle. Please refer to your DCC control station manufacturer's manual for more information on how they handle F Function buttons.

**Your MTH PS3.0-equipped engine's default short address is 3. So all you have to do is power up your DCC system and call up Locomotive 3 to begin.**

## Start-Up/Shut-Down

### F3 - Start-Up/Shut-Down

Pressing this twice (toggle on then off) will start up your engine. When you apply DCC power your MTH PS3.0-equipped engine will remain dark and quiet. Since you likely don't want to run the engine this way, simply press F3 twice to start your engine. The lights, sound and smoke (if equipped) will come on.

**NOTE:** Now your engine will start up just by advancing the throttle. But for the F3 functions (Start Up and Shut Down) to operate, the engine not be moving.

To shut your engine down, press the F3 button twice. This will play the shut down sounds and then turn the lights and smoke and sounds off. As long as there is DCC power still on the track the engine can be started up again by pressing the F3 button twice.

RailKing 4-6-2 Imperial P47 Pacific Steam Engine w/Proto-Sound 3.0

## Sounds

### F1 – Bell

To activate the Bell press F1. To deactivate it, hit F1 again

### F2 – Whistle (Horn)

To activate the Whistle/Horn, press F2. To shut it off either let off the F2 button or press and release it

### F4 – PFA

PFA in MTH lingo stands for Passenger/Freight Announcements. Your engine is pre-programmed for the appropriate type of sounds based upon the type of service the real-life engine used in daily operation.

There are five sound sequences or segments in the PFA feature. Each segment is advanced by you, the operator.

You hit the F4 button twice on the DCC controller to let the engine know you want it to advance (this toggles the PFA function on then off to clear the remote for the next sequence). In most PFA sequences there is a minimum wait time of about 20-30 seconds before it will advance. So, here is how a typical PFA sequence operates:

1. Press the F4 button twice (toggle F4 on then off) to start the PFA sequence on the engine. You'll hear "Now arriving..." for passenger sound sets and cab chatter for freight sound sets. The bell will then begin ringing.
2. Slowly reduce the throttle until the train stops at the desired location and speed reaches zero. Press the F4 button twice (toggle F4 on then off) again and the bell will stop ringing. You will hear the engine sounds switch from the cab to the station or yard with all the ambient sounds you'd hear in the real thing.
3. Press the F4 button twice (toggle F4 on then off) again to advance the sequence. You'll hear "Now boarding..." for passenger sound sets and freight yard sounds for freight sound sets.
4. Press the F4 button twice (toggle F4 on then off) again to advance the sequence. You'll hear "Now departing..." for passenger sound sets and more freight yard sounds for freight sound sets.
5. Press the F4 button twice (toggle F4 on then off) the last time to advance the sequence. You'll hear "All aboard..." for passenger sound sets and more freight yard sounds for freight sound sets. The engine sounds will switch over to the cab again. When the bell begins to ring, advance the throttle to move the engine out of the station or yard. The bell will shut off automatically.

## Lights

### F0 – Headlight/Taillight

This toggles your headlight/taillight on and off.

### F5 – Lights

This toggles your firebox and cab interior light on and off.

## **Master Volume**

### **F6 – Master Volume**

When you activate F6, the Master Volume will begin increasing. If you are at 0 (no volume), the first time you turn on F6 it will take approximately 3 seconds to get to 100% volume. When you get to your desired volume level, turn F6 off.

The next time you toggle F6 on it will drive the Master Volume to 0. If you are at 100% it will take approximately 3 seconds to get to 0. When you arrive at your desired level turn F6 off.

It works like a volume slider – the first time you enable F6 it goes up and stops at 100%. Toggle F6 off and then back on and it will go down to 0 and stop.

## **Couplers**

Your MTH PS3.0-equipped engine comes with remotely controlled Proto-Couplers. They can be fired using your DCC handheld.

### **F7 – Front Coupler**

Pressing F7 twice (toggling on then off) will fire your Front Coupler

### **F8 – Rear Coupler**

Pressing F8 twice (toggling on then off) will fire your Rear Coupler

## **Forward/Reverse Signal**

Just like a real engine, you can announce the direction of intended movement using your DCC handheld and F9 and F10.

### **F9 – Forward Signal**

Pressing F9 twice (toggling on then off) will sound the Forward Signal. This is two whistle/horn blasts

### **F10 – Reverse Signal**

Pressing F10 twice (toggling on then off) will sound the Reverse Signal. This is three whistle/horn blasts

## **Grade Crossing Signal**

Again, just like a real engine, you can trigger the Grade Crossing Signal on your engine. This is two long, one short, one long whistle/horn blast.

### **F11 – Grade Crossing Signal**

Pressing F11 twice (toggling on then off) will sound your Crossing Signal.

## **Smoke (if equipped)**

### **F12 – Smoke On/Off**

Enabling F12 will turn the smoke unit on. Disabling F12 will turn your smoke unit off.

### **F13 – Smoke Volume**

There are three smoke volume levels in your MTH PS3.0-equipped engine – Low/Med/High. The default for this is set to High. You can adjust the smoke output (amount of smoke the generator puts out) by pressing the F13 button twice. This sets the level to the next step. For example, if you are currently at the High smoke output level, pressing F13 twice (toggling it on then off) will set the smoke volume to Low. Pressing F13 twice again will set it to Medium and so on.

## **Engine Sounds**

### **F25 – Engine Sounds**

You can turn the Engine Sounds On/Off by pressing the F25 button. Pressing it once (enabling F25) will cause the Engine Sounds to shut off. The Whistle/Horn and Bell sounds will still be active, however. To turn the engine sounds back on press the F25 button again (disable F25).

## **Additional F Functions**

**NOTE: The engine must be sitting still in order to trigger F-Functions F14 through F18**

### **F14-F16 – Idle Sequence**

Pressing F14, F15, or F16 twice (toggling on then off) will trigger an Idle Sequence if the engine is not moving. These vary from engine to engine and may include things like checking the coal load, checking the water level, using the Alemite grease gun on the drivers, etc. When triggered, these will run through the sequence that varies in duration.

### **F17 – Extended Start-Up**

If your engine is shut down or you've just applied DCC power pressing F17 twice (toggling it on then off) will start the Extended Start-Up sounds. This is very similar to F3 except you will hear the crew talking back and forth about getting the engine ready to run.

### **F18 – Extended Shut-Down**

If your engine is already up and running you can play the Extended Shut Down sounds by pressing F18 twice (toggling on then off). The Extended Shut Down is very similar to F3 in that the engine will ultimately shut down, but in the case of Extended Shut Down you will hear the crew talking back and forth about how the engine ran, time schedules, etc.

### **F19 – Labor Chuff**

To force the Labor Chuff sound in a steam engine, press the F19 button once (enable F19). As long as F19 is enabled the engine will play its Labor Chuff sounds. To set the sound back to Normal Chuff press the F19 button again (disable F19).

### **F20 - Drift Chuff**

To force the Drift Chuff sound in a steam engine, press the F20 button once (enable F20). As long as F20 is enabled the engine will play its Drift Chuff sounds. To set the sound back to Normal Chuff press the F20 button again (disable F20).

### **F21 - One Shot Doppler**

You can set your MTH PS3.0-equipped engine to simulate the actual Doppler Effect sound a real engine makes as it passes you. To do this, press the F21 button once (enable F21) and then listen as the engine makes that pitch shift that mimics the Doppler Effect perfectly. Press the F21 button again (disable F21) to shut off the Doppler Effect. With a little practice in timing and speed you can make this happen right in front of you.

### **F22 - Coupler Slack**

When an engine couples to a train and pulls out, it has to take up the coupler slack. You can play this sound by pressing F22 twice (toggling on then off). This feature works two ways – While the engine is sitting still, press F22 twice to enable it. Then, when you move the engine, it will play the Coupler Slack sound.

The second way is to simply force the sound while the engine is moving. To do this, simply press F22 twice (toggling it on then off). The sound will play.

### **F23 - Coupler Close**

To play the Coupler Close sound press the F23 button twice (toggling it on then off). You can play this sound as you're coupling cars together to add realism.

### **F24 - Single Whistle/Horn Blast**

To play a Single Horn Blast press the F24 button twice (toggling in on then off). This plays a single, short horn blast.

### **F26 - Brake Sounds**

Pressing the F26 button (enable F26) will disable the Brake Sounds for your engine. The Brake Sounds occur when you reduce the speed of your engine rapidly. To enable the Brake Sounds press the F26 button (disable F26). Brake Sounds are On by default.

### **F27 - Cab Chatter**

Cab Chatter occurs when the engine is sitting at idle. There are various times when the crew will talk to each other when the engine is sitting at idle. Pressing the F27 button (enable F27) will disable the Cab Chatter. Pressing the F27 button again (disable F27) will enable Cab Chatter. Cab Chatter is On by default.

### **F28 - Feature Reset**

Resets Features to defaults.

# FUNCTION CHART

| <b>F Key</b> | <b>Description</b>        |
|--------------|---------------------------|
| F0           | Head/Tail light           |
| F1           | Bell                      |
| F2           | Horn                      |
| F3           | Start-Up/Shut Down        |
| F4           | PFA                       |
| F5           | Lights (except head/tail) |
| F6           | Master Volume             |
| F7           | Front Coupler             |
| F8           | Rear Coupler              |
| F9           | Forward Signal            |
| F10          | Reverse Signal            |
| F11          | Grade Crossing            |
| F12          | Smoke (On/Off)            |
| F13          | Smoke Volume              |
| F14          | Idle Sequence 3           |
| F15          | Idle Sequence 2           |
| F16          | Idle Sequence 1           |
| F17          | Extended Start-Up         |
| F18          | Extended Shut-Down        |
| F19          | Labor Chuff               |
| F20          | Drift Chuff               |
| F21          | One Shot Doppler          |
| F22          | Coupler Slack             |
| F23          | Coupler Close             |
| F24          | Single Horn Blast         |
| F25          | Engine Sounds             |
| F26          | Brake Sounds (On/Off)     |
| F27          | Cab Chatter (On/Off)      |
| F28          | Feature Reset             |

## CV29

CV29 is the basic decoder setup CV that is used by all DCC decoder manufactures. So, if you are familiar with CV29 from other manufacturer's decoders M.T.H.'s is no different. The most important part of CV29 is the ability to switch between long and short addressing. By default, CV29 on your M.T.H. PS3.0-equipped engine is set to 2.

### Long and Short Addressing

Like most DCC Decoders, your M.T.H. PS3.0-equipped engine can be programmed with both Long and Short Address. Short addresses are those from 1-127 and Long addresses are those from 128-9999. You can program the engine address either with Programming on the Main (PoM) or using a Programming Track. Since it's easiest, in most cases, to PoM the instructions will show you how to do it this way. By default, your M.T.H. PS3.0-equipped engine comes programmed with both a long and short DCC address. The default Short address is always 3. The default Long address will be 3333.

#### To change your engine's Short Address using PoM:

1. Call up the engine's current address on your DCC handheld
2. Enter Programming on the Main on your DCC handheld
3. Enter the new address you want. Remember, you can only use address 1-127 for Short Addressing
4. Once you hit Enter the engine will give you a two whistle/horn blast response
5. Call up the engine on its new address and away you go.

**NOTE:** If you have elected to use PoM and did not start-up the sounds of your locomotive, you will not hear the two-whistle/horn blast response.

Alternatively, depending upon the type of DCC system you have, you can enter PoM and then write the new address in the Address Menu. This only works for short addressing. For example, on an MRC Prodigy Advance2 system, you would:

1. Call up the engine's current address on your DCC handheld
2. Hit the PROG button twice to enter PoM mode
3. Hit Enter twice so the LCD displays "Adr"
4. Type in the new Short Address (1-127) that you want and hit Enter
5. The engine will give you a two whistle/horn blast response

**NOTE:** If you have elected to use PoM and did not start-up the sounds of your locomotive, you will not hear the two-whistle/horn blast response.

#### To change your engine's Long Address using PoM:

1. Call up the current engine's address on your DCC handheld
2. Enter Programming on the Main on your DCC handheld
3. In the following steps you will need to write values to CV17 and CV18 to tell the engine what the long address should be

In order to determine your required values for CV17 and CV18 you will need to go to [http://extranet.M.T.H.-railking.com/pdfapp/pdfs/instruction/HO%20DCC%20addressCV17\\_18%20Converter.xls](http://extranet.M.T.H.-railking.com/pdfapp/pdfs/instruction/HO%20DCC%20addressCV17_18%20Converter.xls)

Enter in the long address you want then click anywhere else in the spreadsheet and it will return the values for CV17 and CV18 (it will also return the hex conversion of the CV17 and CV18 values if your DCC system requires this).

Below is an example for extended address 2011:

### CV 17 and CV 18 Conversion Tool

| Desired 4-Digit Engine Address | Hex Conversion | C17 Value to Enter | C18 Value to Enter |
|--------------------------------|----------------|--------------------|--------------------|
| 2011                           | 07DB           | 199                | 219                |

4. Call up CV17 and enter the value required for CV17. You will get a two whistle/horn blast response
5. Call up CV18 and enter the value required for CV18. You will get a two whistle/horn blast response
6. In this step you have to tell the M.T.H. engine that you want it to start looking at long addresses. You do this in CV29:
  - a. Bring up the CV menu on your DCC handheld
  - b. Enter “29” to edit CV29
  - c. Enter “38” to change the value of CV29 and hit Enter
  - d. The engine will give you a two-whistle/horn blast response.

**NOTE:** If you have elected to use PoM and did not start-up the sounds of your locomotive, you will not hear the two-whistle/horn blast response.

### Feature/Factory Resetting

Please note, when making setting changes in DCS or DCC, such as address, please wait a minimum of 5 seconds after removing power to insure the settings are stored in the engines memory. Reapplying power in less than 5 seconds may result in losing the setting changes. If all else fails and you aren't sure of something, never fear. You can always get your engine back to a known state by either performing a Feature or Factory Reset.

There are a couple of ways to reset your M.T.H. PS3.0-equipped engine:

**Factory Resets:** Clears everything (makes engine just like it was when you bought it new)

- Send a decimal 08 to CV8 to reset everything entirely back to factory default
- Send a decimal 192 to reset everything except user speed tables

**Feature Resets:** There are a couple of Feature Resets that you can use

- Press F28 twice (toggling on then off). This resets the smoke, volume and lights back to their defaults
- Send a decimal 64 for a Feature Reset. This resets volumes, smoke and light settings.
- Send a decimal 128 to reset only address values back to factory default
  - This is the same as writing 55 to CV55 to engine address 55

**NOTE:** The engine address has to be something other than address 55

RailKing 4-6-2 Imperial P47 Pacific Steam Engine w/Proto-Sound 3.0



## Lost or Unknown Engine Address and the 55-55-55 Address Reset

In some cases you may not remember or have somehow lost the engine address. Following the above Feature or Factory Resets will allow you to recover an engine. The limitation to this is that for most resets you must know the engine address. If you are unsure of the engine address you can apply the 55-55-55 reset (send a value of 55 to CV55 to engine address 55). In order for this to work correctly the engine's address must NOT be 55. The engine will need to be sitting at some address other than 55.

Below is the method (55-55-55 Reset) you can employ to return an engine to its factory default short address of 3 (it will also set the engine's long address back to its default – usually 3333 or the cab number on some models) if you're unsure of the engine's current address:

- Check first to see if the engine happens to be sitting at address 55. Call up engine 55 on your DCC handheld and hit F3 to start the engine up. If it starts up then you can change the address to whatever you want using CV1 (short address) or CV17 and CV18 (long address)
- If the engine doesn't start up at address 55 then you can use the 55-55-55 reset. To perform this follow the instructions below:
  - Ensure the DCC system is powered up and power is on the rails
  - Call up engine address 55. **NOTE:** you are NOT changing the engine's address to 55 you are just telling the DCC system to start talking to engine address 55. You will want to make sure that no other M.T.H. engines are on the rails or any other manufacturer's engines with an address of 55 are on the rails. M.T.H. engines will listen for commands coming to engine address 55 when the 55-55-55 reset is enabled even though they are not programmed as address 55
  - Enter PoM mode on your DCC handheld and write a value of 55 to CV55. Again, even though your M.T.H. engine is NOT on address 55 it will still listen for this reset command
  - Call up address 3 on your DCC handheld and hit F3. The engine should now start-up

If you have performed the 55-55-55 reset and the engine still doesn't respond then place the engine on the programming track output of your DCC system and program a value of 3 to CV1. This will set the engine's short address to 3. However, as long as the engine is NOT programmed as address 55 then the 55-55-55 reset will always set the engine's long and short addresses back to their factory defaults. It will also set the engine's addressing back to short (if you happened to have CV29 set to long addressing)

The 55-55-55 Reset can be confusing at first but the main point to note is that you are NOT setting the engine's address to 55 to perform the reset, you are just calling up engine address 55 on your DCC handheld and sending a value of 55 to CV55. Again, M.T.H. engine's will listen to the 55-55-55 reset command even though the engine's address isn't actually 55 (and it can't be for the 55-55-55 reset to work).

# MTH PS3.0 Expanded DCC Functionality

## Advanced DCC Operation

This section of the manual provides more in-depth detail on how to set up and configure your MTH PS3.0-equipped engine using the NMRA-standard CV's as well as the manufacturer-specific CV's. It also explains some of the other F Functions not covered in the Basic DCC Operation section.

## Configuration Variables (CV)

Configuration Variables used on MTH PS3.0-equipped engines.

|                 |   |
|-----------------|---|
| CV1             | Short Address: 1-127 are the valid addresses  |
| CV2             | Start Voltage <sup>1</sup>  |
| CV3             | Acceleration Rate <sup>1</sup>  |
| CV4             | Deceleration Rate <sup>1</sup>  |
| CV5             | Max Voltage <sup>1</sup>  |
| CV8             | MFG ID. MTH =27 (Also used for various resets)  |
| CV11            | Packet Timeout  |
| CV17            | High Byte of Extended Address   |
| CV18            | Low Byte of Extended Address  |
| CV19            | Consist Address (bit 7=1 on an engine will tell the engine it's reversed in a consist)  |
| CV21            | Defines active Function F1-F8 for the active consist  |
| CV22            | Defines active functions for FL and F9-F12 for the active consist (bit 0=1 will tell an engine that you want it's FL control to operate under the consist address – bit1-0/bit2=1 will configure the FL control for a reversed engine in a consist) |
| CV23            | Consist Acceleration Rate   |
| CV24            | Consist Deceleration Adjustment   |
| CV25            | Speed Table Select  |
| CV29            | Decoder Configuration   |
| CV49            | Short Address (controllers that prohibit PoM)   |
| CV50            | Extended Addr High Byte (controllers that prohibit PoM)   |
| CV51            | Extended Addr Low Byte (controllers that prohibit PoM)  |
| CV52            | MTH/PWM Mode Configuration  |
| CV53            | MTH Acceleration (1/8 *sMPH/s) (For example - a Value of 8 written would give you 1sMPH/s acceleration)   |
| CV54            | MTH Deceleration Rate (1/8*sMPH/s)  |
| CV55            | Factory Address Reset Alternate method. Send a value of 55 to CV55 on address 55 and the model will go back to the Factory Default Address.<br><b>NOTE: The engine address has to be something other than address 55</b>                            |
| CV56            | Marklin Configuration   |
| CV57            | Anti-Jackrabbit Toggle. A value of 7 disables the feature, a value of 0 enables the feature.  |
| CV63            | MTH Consist Acceleration Rate (1/8*sMPH/s)  |
| CV64            | MTH Consist Deceleration Rate (1/8*sMPH/s)  |
| CV66            | Forward Trim <sup>1</sup>   |
| CV67-<br>CV94   | Speed Table Selection (CV29 bit 4 must be set to 1 then CV25 must be set to 0 or 1)   |
| CV95            | Reverse Trim <sup>1</sup>   |
| CV105           | User ID #1 – General Purpose use for customer   |
| CV106           | User ID #2 – General Purpose use for customer   |
| CV115-<br>CV170 | MTH Function Assignments – See table of supported CV's and manual section on how to re-arrange them for further information   |

1. CV52, bit0 must = 1. This will enable PWM Mode.

## Factory Default Values for MTH PS3.0 DCC Configuration Variables (CV's)

| Default Value | Range   | Description   | CV  | F-Key | Description                   | CV  |
|---------------|---------|---|-----|-------|-------------------------------|-----|
| 3             | 0-127   | Short Address   | 1   | 1     | Bell High Byte                | 115 |
| 16            | 0-255   | Start Voltage (Cv52 bit 0 must =1)                      | 2   | 1     | Bell Low Byte                 | 116 |
| 0             | 0-255   | Accel Adjustment  | 3   | 2     | Horn High Byte                | 117 |
| 0             | 0-255   | Decel Adjustment  | 4   | 2     | Horn Low Byte                 | 118 |
| 0             | 0-255   | Max Voltage (Cv52 bit 0 must =1)                        | 5   | 3     | Start-Up/Shut Down High Byte  | 119 |
| 0             | -       | NMRA Mfg Version  | 7   | 3     | Start-Up/Shut Down Low Byte   | 120 |
| 27            | -       | NMRA Mfg ID   | 8   | 4     | PFA High Byte                 | 121 |
| 0             | 0-255   | Packet Timeout  | 11  | 4     | PFA Low Byte                  | 122 |
| 205           | 192-231 | Extended Address High Byte                              | 17  | 5     | Lights High Byte              | 123 |
| 5             | 0-255   | Extended Address Low Byte                               | 18  | 5     | Lights Low Byte               | 124 |
| 0             | 0-255   | Consist Address   | 19  | 6     | Master Volume High Byte       | 125 |
| 0             | 0-255   | Consist Functions F1-F8                                 | 21  | 6     | Master Volume Low Byte        | 126 |
| 0             | 0-255   | Consist Functions F9-F12                                | 22  | 7     | Front Coupler High Byte       | 127 |
| 0             | 0-255   | Consist Acceleration Adjustment                         | 23  | 7     | Front Coupler Low Byte        | 128 |
| 0             | 0-255   | Consist Deceleration Adjustment                         | 24  | 8     | Rear Coupler High Byte        | 129 |
| 0             | 0-127   | Speed Table Select                                      | 25  | 8     | Rear Coupler Low Byte         | 130 |
| 2             | 0-255   | Decoder Configuration                                   | 29  | 9     | Forward Signal High Byte      | 131 |
| -             | 0-127   | Short Address (controllers that prohibit PoM)           | 49  | 9     | Forward Signal Low Byte       | 132 |
| -             | 192-231 | Extended Addr High Byte (controllers that prohibit PoM) | 50  | 10    | Reverse Signal High Byte      | 133 |
| -             | 0-255   | Extended Addr Low Byte (controllers that prohibit PoM)  | 51  | 10    | Reverse Signal Low Byte       | 134 |
| 0             | 0-255   | MTH/PWM Mode Configuration                              | 52  | 11    | Grade Crossing High Byte      | 135 |
| 128           | 0-255   | MTH Acceleration Rate                                   | 53  | 11    | Grade Crossing Low Byte       | 136 |
| 64            | 0-255   | MTH Deceleration Rate                                   | 54  | 12    | Smoke On/Off High Byte        | 137 |
| 0             | 0-255   | Marklin Configuration                                   | 56  | 12    | Smoke On/Off Low Byte         | 138 |
| 0             | 0-255   | Anti-Jackrabbit   | 57  | 13    | Smoke Volume High Byte        | 139 |
| 0             | 0-255   | MTH Consist Acceleration Rate                           | 63  | 13    | Smoke Volume Low Byte         | 140 |
| 0             | 0-255   | MTH Consist Deceleration Rate                           | 64  | 14    | Idle Sequence 3 High Byte     | 141 |
| 0             | 0-255   | Forward Trim  | 66  | 14    | Idle Sequence 3 Low Byte      | 142 |
| 0             | 0-255   | Alternate Speed Curve Step 1                            | 67  | 15    | Idle Sequence 2 High Byte     | 143 |
| 9             | 0-255   | Alternate Speed Curve Step 2                            | 68  | 15    | Idle Sequence 2 Low Byte      | 144 |
| 19            | 0-255   | Alternate Speed Curve Step 3                            | 69  | 16    | Idle Sequence 1 High Byte     | 145 |
| 28            | 0-255   | Alternate Speed Curve Step 4                            | 70  | 16    | Idle Sequence 1 Low Byte      | 146 |
| 38            | 0-255   | Alternate Speed Curve Step 5                            | 71  | 17    | Extended Start-Up High Byte   | 147 |
| 47            | 0-255   | Alternate Speed Curve Step 6                            | 72  | 17    | Extended Start-Up Low Byte    | 148 |
| 57            | 0-255   | Alternate Speed Curve Step 7                            | 73  | 18    | Extended Shut Down High Byte  | 149 |
| 66            | 0-255   | Alternate Speed Curve Step 8                            | 74  | 18    | Extended Shut Down Low Byte   | 150 |
| 76            | 0-255   | Alternate Speed Curve Step 9                            | 75  | 19    | Labor Chuff High Byte         | 151 |
| 85            | 0-255   | Alternate Speed Curve Step 10                           | 76  | 19    | Labor Chuff Low Byte          | 152 |
| 94            | 0-255   | Alternate Speed Curve Step 11                           | 77  | 20    | Drift Chuff High Byte         | 153 |
| 104           | 0-255   | Alternate Speed Curve Step 12                           | 78  | 20    | Drift Chuff Low Byte          | 154 |
| 113           | 0-255   | Alternate Speed Curve Step 13                           | 79  | 21    | One Shot Doppler High Byte    | 155 |
| 123           | 0-255   | Alternate Speed Curve Step 14                           | 80  | 21    | One Shot Doppler Low Byte     | 156 |
| 132           | 0-255   | Alternate Speed Curve Step 15                           | 81  | 22    | Coupler Slack High Byte       | 157 |
| 142           | 0-255   | Alternate Speed Curve Step 16                           | 82  | 22    | Coupler Slack Low Byte        | 158 |
| 151           | 0-255   | Alternate Speed Curve Step 17                           | 83  | 23    | Coupler Close High Byte       | 159 |
| 161           | 0-255   | Alternate Speed Curve Step 18                           | 84  | 23    | Coupler Close Low Byte        | 160 |
| 170           | 0-255   | Alternate Speed Curve Step 19                           | 85  | 24    | Single Horn Blast High Byte   | 161 |
| 179           | 0-255   | Alternate Speed Curve Step 20                           | 86  | 24    | Single Horn Blast Low Byte    | 162 |
| 189           | 0-255   | Alternate Speed Curve Step 21                           | 87  | 25    | Engine Sounds High Byte       | 163 |
| 198           | 0-255   | Alternate Speed Curve Step 22                           | 88  | 25    | Engine Sounds Low Byte        | 164 |
| 208           | 0-255   | Alternate Speed Curve Step 23                           | 89  | 26    | Brake Sounds On/Off High Byte | 165 |
| 217           | 0-255   | Alternate Speed Curve Step 24                           | 90  | 26    | Brake Sounds On/Off Low Byte  | 166 |
| 227           | 0-255   | Alternate Speed Curve Step 25                           | 91  | 27    | Cab Chatter On/Off High Byte  | 167 |
| 236           | 0-255   | Alternate Speed Curve Step 26                           | 92  | 27    | Cab Chatter On/Off Low Byte   | 168 |
| 246           | 0-255   | Alternate Speed Curve Step 27                           | 93  | 28    | Feature Reset High Byte       | 169 |
| 255           | 0-255   | Alternate Speed Curve Step 28                           | 94  | 28    | Feature Reset Low Byte        | 170 |
| 0             | 0-255   | Reverse Trim  | 95  |       |                               |     |
| 0             | 0-255   | User ID #1  | 105 |       |                               |     |
| 0             | 0-255   | User ID #2  | 106 |       |                               |     |

## User-Settable F-Function List

This feature allows you to take the 28 F-Functions that currently reside in each MTH Proto-Sound 3.0-equipped O-Gauge Engine and change the location of that function. For example: F4 is currently PFA and you'd like that placed down to F28 which is Feature Reset. The below instructions explain how you can do this.

**NOTE:** When you set a particular F-Function to a numeric location you are overwriting that existing number's function. Further, you are leaving the location where the previous function was moved from empty, which means that F-Function no longer has any function associated with it

In order to move the F-Functions around you will need to refer to the below table.

**NOTE:** The Function Identification number IS NOT the F Function number you would use on your DCC handheld. It is used internally in the engine.

## Function Identification Chart

| SOUNDS                | FUNCTION IDENTIFICATION | OTHER FUNCTIONS               | FUNCTION IDENTIFICATION |
|-----------------------|-------------------------|-------------------------------|-------------------------|
| Bell                  | 1                       | Feature Reset                 | 29                      |
| Brake Sounds          | 2                       | Front Coupler                 | 30                      |
| Cab Chatter           | 3                       | Front Pantograph              |                         |
| Clickety Clack        | 4                       | Up/Down                       | 31                      |
| Coupler Close         | 5                       | Pantograph                    |                         |
| Coupler Slack         | 6                       | Auto/Manual                   | 32                      |
| Drift Chuff           | 7                       | Rear Coupler                  | 33                      |
| Engine Sounds         | 8                       | Rear Pantograph               |                         |
| Forward Signal        | 9                       | Up/Down                       | 34                      |
| Grade Crossing Signal | 10                      | Rev Down                      | 35                      |
| Horn                  | 11                      | Rev Up                        | 36                      |
| Idle Sequence 1       | 12                      | Smoke On/Off                  | 37                      |
| Idle Sequence 2       | 13                      | Smoke Volume                  | 38                      |
| Idle Sequence 3       | 14                      | Disable Momentum (Motorola)   | 40                      |
| Idle Sequence 4       | 15                      | Half-Speed (Motorola)         | 41                      |
| Labor Chuff           | 16                      | Switching (combination of     |                         |
| Master Volume         | 17                      | Momentum and Half-Speed)      | 42                      |
| Short Horn            | 18                      |                               |                         |
| One Shot Doppler      | 19                      | <b>LIGHTS</b>                 |                         |
| Reverse Signal        | 20                      | Lights                        | 39                      |
|                       |                         | Marker (Train/No Train)       | 43                      |
|                       |                         | Beacon (Alt Lighting/Country) | 44                      |
| <b>SCRIPTS</b>        |                         | <b>ELECTRIC SMOKE</b>         |                         |
| Extended Shut Down    | 21                      | Electric Boiler Start-Up      | 45                      |
| Extended Start Up     | 22                      | Electric Pressure Release     | 46                      |
| PFA                   | 23                      |                               |                         |
| Start Up/Shut Down    | 24                      | Trolley Random Stops          | 47                      |
| Train Wreck           | 25                      |                               |                         |
| Trolley Manual Mode   | 26                      |                               |                         |
| Trolley Learn Mode    | 27                      |                               |                         |
| Trolley Auto Mode     | 28                      |                               |                         |

The above list includes ALL F functions that an MTH PS3 engine could have. You are free to change any of the above listed items to any F function position, 1-28. For example, if you your engine came from the factory without a smoke unit but you added one at a later date you could swap out any of the F functions, 1-28, for the Smoke On/Off and the Smoke Volume.

So, using the example above of moving F4 to F28 here are the steps:

1. Refer the MTH Supported CV table to see what CV the destination Function is assigned to. In doing so, you are looking only for the Low Byte CV location. In this case it's CV170
2. Using your DCC system, bring up CV programming for CV170
3. Now tell the engine which F-Function you want to write at CV170. So, looking at the Function ID table above you can see that PFA is a value of 23
4. Using your DCC system, enter a value of 23 for CV170 and hit Enter. You have just re-assigned the PFA sound to F28 on your DCC controller. The engine will give you a two horn blast indication. Note – You've also left an empty location where PFA used to be (F4)
5. Now you can fill that location with whichever CV you'd like. For this example we are just going to move the Feature Reset up to F4 (we're just swapping F4 and F28)
6. Since F4's Low Byte is CV122 then bring up CV programming for CV122
7. Now tell the engine which F-Function you want to write at CV122. So, looking at the Function ID table above you can see that Feature Reset is a value of 29
8. Using your DCC system, enter a value of 29 for CV122 and hit Enter. Your engine will give you a two horn blast indication

## Custom Speed Tables

Below is a table that shows the value to write to CV25 to achieve the desired speed curve. For example, if you would like to use speed curve 18 then:

1. Write a value of 1 to CV52 to enable PWM Mode
2. Write a value of 1 to bit 4 of CV29
3. Write a value of 18 to CV25. Your engine will now use the speed curve #18 below
4. If you want to create your own speed table using CV's 67-94 then write a value of 0 or 1 to CV25

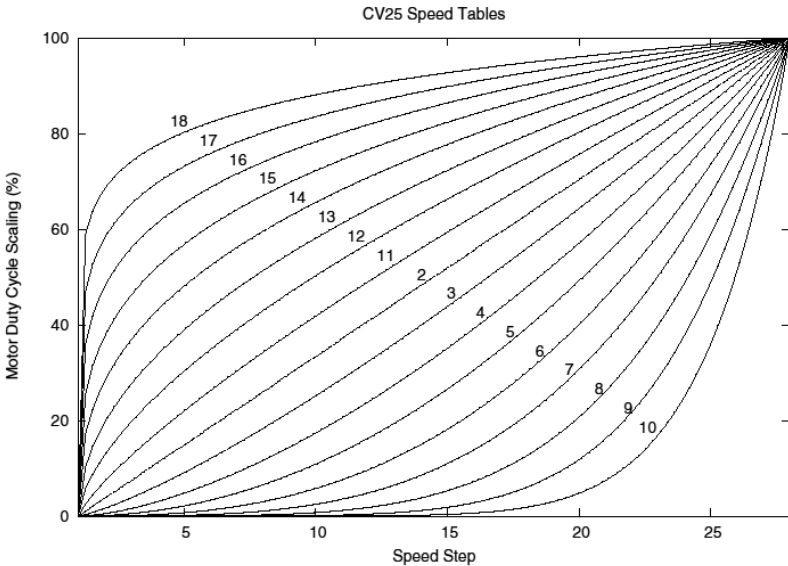

## Advanced Consisting

Advanced Consisting follows the NMRA standards. Any values assigned to CV's 21-24 are ignored once the consist is removed (CV19 set to 0).

- Setting the MSB (Bit 7) of CV19 tells the engine that it is facing reverse in the consist
- Setting CV21 and CV22 determine which F Functions the consist responds to

See diagram below for example

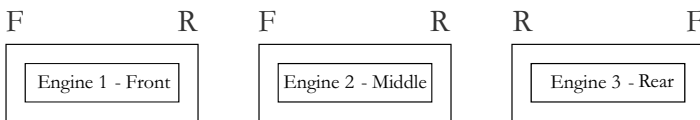

← Normal Forward Direction of Travel

### **To set this consists up so that:**

- The Headlight is ON in the Front engine when going Forward, OFF when the consist is in Reverse
- The Reverse light and headlight is OFF in the Rear engine when the consist is going Forward, headlight is ON, reverse light is OFF when the consist is in Reverse
- The Middle engine has no lights in either direction

### **Perform the following:**

1. Build the consist using your DCC system per the DCC system's manufacturer's instructions. In many newer systems you have the ability to tell the system which engine is reversed. Remember the consist address you told the DCC system to be built at as you'll need to come back to that address to actually run the consist. The instructions assume only CV19 gets the consists address and nothing more
2. Call up the Front engine on your DCC handheld; address 1 in this example
3. Select CV22 and write a value of 1. This tells the engine that it's a forward facing engine and that you want F0 to control the FL function at the consist address. The engine will give you two horn blasts to announce that it received the CV change
4. Ensure F0 is deactivated at the Front engine's address. Most systems have a light bulb icon to indicate whether F0 is active or not. Ensure that it is OFF
5. Call up the Rear engine on your DCC handheld; address 3 in this example
6. Set CV19 to  $128 +$  the value of your consist address
  - So, if your consist address is 4 you would add  $128+4=132$ . You would write 132 to CV19. This tells the Rear engine that it's reversed in the consist. You will get two horn blasts to announce that it received the CV change. Some DCC systems may already do this for you but the instructions assume your system does not. If you are in doubt then go ahead and follow step 5 as it will do no harm
7. Set CV22 to a value of 2 to the Rear engine's address to tell the Rear engine that you want to control its FL control with the F0 button at the consist address. The engine will give you two horn blasts to announce that it received the CV change
8. Ensure F0 is deactivated at the Rear engine's address. Most systems have a light bulb icon to indicate whether F0 is active or not. Ensure that it is OFF
9. Call up the Middle engine on your DCC handheld; address 2 in this example
10. Ensure F5 and F0 are toggled OFF. You may have to toggle F5 on/off a couple times to get the lights in sync with the DCC command station. This will depend upon your DCC system

11. Call up the consist address (address 4 in this example)
12. Press the F0 button to ensure the FL is toggled on. Most systems have a light bulb icon to indicate whether F0 is active or not. Ensure that it is ON

**NOTE:** The convenient thing about setting up the consist as described above is that it allows you flexibility in the orientation of an engine in a consist; particularly the head and tail engines where the FL control is integral. For example, if you wanted to flip the Rear engine around and make it face forward in the consist all you'd have to do is go into the Rear engine's address (address 3 in the example) and clear bit 7 of CV19. In other words, just write the consist's address to CV19. The FL control will automatically understand what you've done so there is no need to go in and change CV22.

Below is a table that outlines which bits correspond to what F Functions F0, F9-F12 are used in a consist:

| Bit (Decimal Value) | 7 (128) Not Used | 6 (64) Not Used | 5 (32) | 4 (16) | 3 (8) | 2 (4) | 1 (2)                  | 0 (1)                  |
|---------------------|------------------|-----------------|--------|--------|-------|-------|------------------------|------------------------|
| F Function          | Not Used         | Not Used        | F12    | F11    | F10   | F9    | F0 (Engine Facing Rev) | F0 (Engine Facing Fwd) |

## Setting Up CV21 for a Consist

Cv21 allows you to set which F Functions you want the consist address to control. For example, you will likely want all of your MTH consist engines to respond to Start-Up/Shut Down (F3). Also, you'll likely want at your Front engine to respond to the Bell and Horn commands (F1 and F2, respectively) and the Front Coupler (F7 on most MTH models). Likewise, you'll want your Rear engine to respond to the Rear Coupler command (F8 on most MTH models).

Please refer to the table below to see which bits have what decimal value and which F Function they correspond to.

### To do this:

1. Call up the Front engine on your DCC system
2. To set the Front engine to respond to the Bell (F1), Horn (F2), Start-Up/Shut Down (F3) and Front Coupler (F7) you will want to write a value of 71 to CV21. This is setting bits 0, 1, 2, and 6 ON.
  - a. CV21's bits are shown in the table below – the decimal value is shown in parenthesis:

| Bit (Decimal Value) | 7 (128) | 6 (64) | 5 (32) | 4 (16) | 3 (8) | 2 (4) | 1 (2) | 0 (1) |
|---------------------|---------|--------|--------|--------|-------|-------|-------|-------|
| F Function          | F8      | F7     | F6     | F5     | F4    | F3    | F2    | F1    |



**NOTE:** CV21 is ONLY used when you have some value other than 0 written to CV19. If CV19 = 0 then the values of CV21, CV22, CV23, and CV24 are not used

3. Call up your Middle engine (address 2 in the example)
4. Since you want to have the Middle engine respond to F3 only then write a value of 4 (CV21, bit 2 = ON)
5. Call up your Rear engine (address 3 in the example)
6. Since you want to have the Rear engine respond to the Start-Up/Shut Down (F3) and Rear Coupler (F8) functions you want to write a value of 132 to CV21

Your engines are now set up according to the example above.

You will note that there is no F0 in CV21. This is because that function (FL) is controlled by CV22. Please refer to the Advanced Consisting section for more information regarding CV22.

## Programming Track

Your MTH Proto-Sound 3.0-equipped locomotive does not program well on Programming tracks due to the inclusion of super capacitors utilized in the locomotive's electronic package. The super capacitors provide backup power to the electronics, allowing the locomotive to better negotiate track sections suffering from poor electrical conductivity. This ensures that sounds continue to play, the locomotive continues to move forward and lighting remains lit. During power shutdowns, the super capacitors provide power to allow the locomotive shutdown sounds to continue playing through their conclusion. Unfortunately, the super capacitors require that operators ONLY program engine CV's using Programming on the Main (PoM).

## DCC Bit Value Decoder

| Example Value (bit 7 -> bit 0) 11011001 |         |        |         |        |        |         |         |        |
|---|---------|--------|---------|--------|--------|---------|---------|--------|
| Bit<br>(Decimal<br>Value)               | 7 (128) | 6 (64) | 5 (32)  | 4 (16) | 3 (8)  | 2 (4)   | 1 (2)   | 0 (1)  |
| Binary<br>Example                       | 1 (on)  | 1 (on) | 0 (off) | 1 (on) | 1 (on) | 0 (off) | 0 (off) | 1 (on) |
| Decimal<br>Value                        | 128     | 64     | 0       | 16     | 8      | 0       | 0       | 1      |

So, in the above example you simply add up the values in the “Decimal Value” row –  $128+64+0+16+8 +0+0+1 = 217$ . You would write 217 to the CV you were altering.

The above applies to any CV. Also, if you have a CV that already has a value assigned that you do not want to alter but need to make additions to it, for example CV29, you would simply add the additional bits you enabled to the existing value to obtain the new CV value.

For example, if you had a consist address (CV19) set to 5 and you wanted to alter this to show an engine reversed in the consist you would need to set bit 7 (decimal value = 128) for the engine you want to reverse. To do this - take 128 (the new bit you want to set) + 5 (the existing bit that you do not want to alter) = 133. You would then write a value of 133 to CV19.

# Maintenance

## Lubricating and Greasing Instructions

The engine should be well oiled and greased in order to run properly. Regularly lubricate all side rods, linkage components and pickup rollers to prevent them from squeaking. Use light household oil and follow the lubrication points marked “L” below. Do not over-oil. Use only a drop or two on each pivot point.

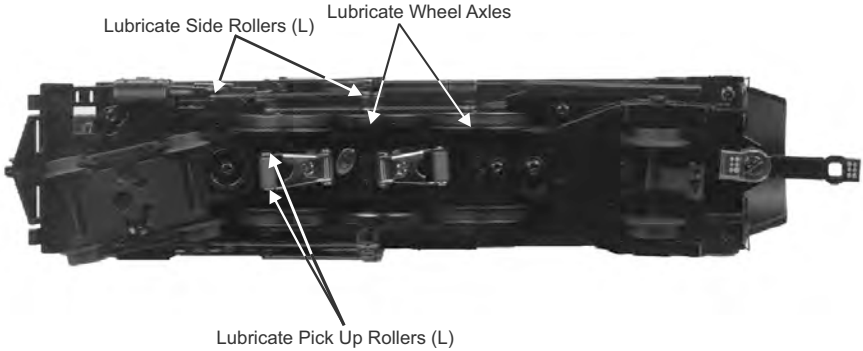
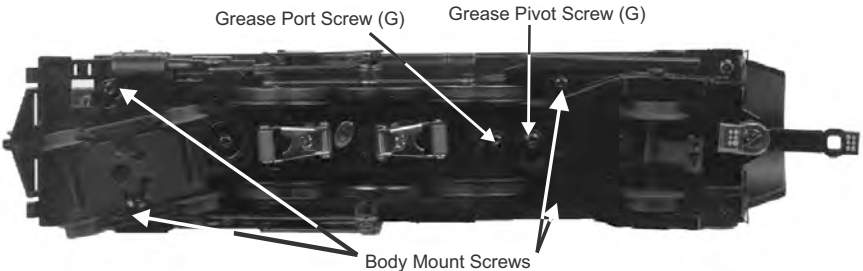

*Figure: Lubricating the Locomotive*

The locomotive’s internal gearing was greased at the factory and should not need additional grease until after 50 hours of operation or one year, whichever comes first. To access the gear box and axles, do the following:

1. Turn the engine upside down.
2. Remove the Phillips screws (marked “GREASE”).
3. Use a grease tube dispenser to put a small amount (approx. 1-2 ml.) of lithium-based grease into the gearbox and axles.

You should also grease the leading and trailing locomotive truck tongues to enhance their ability to slide on the chassis. Follow the grease points.



*Figure: Body Mount Screws and Grease Points*

## Cleaning The Wheels, Tires and Track

Periodically check the locomotive wheels and pickups for dirt and buildup, which can cause poor electrical contact and traction and prematurely wear out the neoprene traction tires. Wheels and tires can be cleaned using denatured (not rubbing) alcohol applied with a cotton swab.

To clean the track, use RailKing® Track Cleaning Fluid or denatured (not rubbing) alcohol and a clean rag. Unplug the transformer and wipe the rails of the track, turning the rag frequently to ensure that you are using clean cloth on the rails. Thereafter, keep an eye on the track and clean it when it gets dirty to ensure good electrical contact and to lengthen the life of the tires.

Clean any type of track with this heavy-duty track cleaning block (40-1099). Durable constructed from ABS plastic, the block includes a built-in cleaning pad. For really stubborn track, you can insert sandpaper into the block in just a few quick steps.



Maintenance Kit  
(30-50051)

Track Cleaning  
Block (40-1099)

## Traction Tire Replacement Instructions

Your locomotive is equipped with four neoprene rubber traction tires on the rear set of flanged drivers. While these tires are extremely durable, they may occasionally need to be replaced.

Remove the side rods (the rods that connect each drive wheel to the other) from the wheels in order to slip the new tire over the grooved drive wheel. These bolts can be loosened with a 5mm nutdriver.

Make sure the old tire has been completely removed from the groove in the drive wheel, using a razor blade or small flathead screwdriver to pry away any remains.

Clean the groove using a cotton swab and denatured alcohol.

Slip the new tire onto the wheel. You may find it useful to use two small flathead screwdrivers to stretch the tire over the wheel.

If you twist the tire while stretching it over the wheel, you will need to remove and reinstall the tire. Otherwise your engine will wobble while operating.

Make sure the tire is fully seated inside the groove. Use a razor blade to trim away any excess tire that doesn't seat itself inside the groove properly.

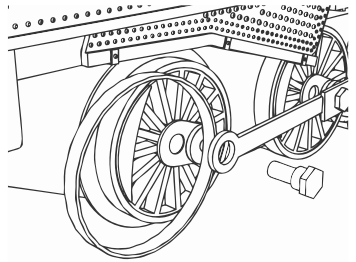
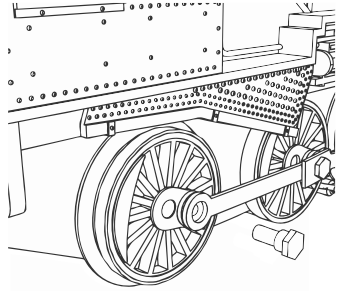

## ProtoSmoke™ Unit Operation

This steam locomotive contains a smoke unit that outputs smoke through the smokestack on the boiler of the engine. The smoke unit is essentially a small heating element and wick that soaks up and then heats a mineral oil-based fluid that emits a harmless smoke. The smoke is then forced out of the stack by a small electric fan. With a few easy maintenance steps, you should enjoy trouble-free smoke unit operation for years.

When preparing to run this engine, add 15-20 drops of smoke fluid through the smokestack. We recommend M.T.H. ProtoSmoke fluid (a small pipette of ProtoSmoke fluid is included). Do not overfill the unit or the fluid may leak out and coat the interior engine components.

If you choose not to add the fluid (or have already added the fluid but choose to run smoke-free), turn off the smoke unit control (Full Counter Clockwise Position) located under the tender body. **Failure either to add fluid to the unit or to turn it off may damage the smoke unit heating element and/or wicking material.**

When the smoke output while running the engine begins to diminish, add another 10-15 drops of smoke fluid or turn the smoke unit off.

When storing the unit for long periods of time, you may want to add about 15 drops of fluid to prevent the wick from drying out.

If you experience poor or no smoke output when the smoke unit is on and has fluid, check the wick to see if it has become hard, blackened, and unabsorbent around the heating element. To do this first remove the 4 body mounting screws and remove the locomotive's body (see figure on page 35). Then remove the smoke unit cover screws, lift the smoke unit cover away, and inspect the wick. If it is darkly discolored and hard, it should be replaced. When priming new wick add 40 drops.



Figure: Adding Fluid



Smoke Unit Cover



Wick in Poor Condition      Wick in Good Condition

## Headlight Replacement

The PS 3.0 headlights and other associated lights are small LEDs that require a lot less power and generate a lot less heat than incandescent bulbs, resulting in extremely long life compared to the incandescent bulbs. The LEDs are not user serviceable.

# Troubleshooting Proto-Sound® 3.0 Problems

Although Proto-Sound® 3.0 has been designed and engineered for ease of use, you may have some questions during initial operation. The following table should answer most questions. If your problem cannot be resolved with this table, contact M.T.H. for assistance (telephone: 410-381-2580; fax: 410-423-0009; service@mth-railking.com, 7020 Columbia Gateway Drive, Columbia MD 21046-1532).

## Conventional AC

| <b>Starting Up</b>  | <b>Solution</b>   |
|---|---|
| Only my headlight comes on, nothing else.                         | This is normal behavior. The super capacitors are charging and this will take between 1-20 seconds.   |
| When I first turn the power on, the engine will not begin to run. | This is normal behavior. To prevent accidental high-speed start-ups, Proto-Sound® 3.0 is programmed to start up in neutral anytime track power has been turned off for several seconds. See the "Basic Operation" section for more details. |
| The engine will not start after I press the Direction button.     | You may not be sending enough power to the track to power the engine. Rotate throttle clockwise to increase track power.  |
| <b>Horn</b>   | <b>Solution</b>   |
| I can't get the horn to blow when I press the Horn button.        | You may be pressing the button too quickly. Try pressing the Horn button more slowly, taking approximately one full second to fully depress the button.   |
| <b>Bell</b>   | <b>Solution</b>   |
| I can't get the bell to ring when I press the bell button.        | You may be pressing the button too quickly. Try pressing the bell button more slowly, taking approximately one full second to fully depress the button.   |
| <b>Coupler</b>  | <b>Solution</b>   |
| When I try to fire the coupler, PFA starts.                       | You are waiting too long between Horn button presses. See the timing instructions located at the beginning of the "Proto-Sound® 3.0 Operating Instructions" section.  |
| The Proto-Coupler™ won't let the engine uncouple on the fly.      | Try lubricating the coupler knuckle and rivet with a dry graphite lubricant.  |
| The coupler does not fire or stay coupled.                        | The coupler needs to be cleaned. Wipe with denatured alcohol (not rubbing alcohol) and let dry.   |
| <b>Cab Chatter</b>  | <b>Solution</b>   |
| Sometimes the Cab Chatter sounds don't play.                      | Cab Chatter plays only in neutral at random intervals.  |

## Conventional AC

| <b>Lock-out</b>   | <b>Solution</b>   |
|---|---|
| I can't get the engine to run after I power up the transformer. It sits still with the diesel and compressor sounds running. The engine won't lock into forward, neutral, or reverse. | The engine maybe locked into the neutral position. Follow the procedure in the "Lock into a Direction" section to unlock the engine's direction. Engine speed must be below 10 scale mph (approx. 10 volts or less in conventional mode). |
| <b>Volume</b>   | <b>Solution</b>   |
| The sounds seem distorted, especially when the Horn or bell is activated.   | Proto-Sound® 3.0 volume is set too high. Turn the volume control knob on the bottom of the tender counter-clockwise to reduce the volume.   |
| No Sound  | Volume is set too low, adjust volume control knob on the bottom of the chassis clockwise to increase the volume or check connector to speaker.  |
| <b>PFA</b>  | <b>Solution</b>   |
| Once in PFA, the engine doesn't go into reverse.  | So that PFA effects can be as realistic as possible, Proto-Sound® 3.0 disables the reversing unit whenever PFA is enabled. This way the engine remains still at its stop as the operator cycles through the PFA sequences.                |
| When the PFA enters its last sequence the bell automatically comes on.  | PFA is programmed to start ringing the bell at that point. After approximately 12 seconds, it will automatically turn off.  |
| When PFA is enabled, pressing the whistle and bell has no effect.   | Because PFA must control various effects in each sequence, Proto-Sound® 3.0 takes control of these sound effects until you exit PFA   |
| I push the direction button but the next sound clip in the sequence does not play or the engine does not come out of PFA after fourth press of the direction button.                  | Each PFA clip must play for aprox. 30 seconds before PFA will advance to the next step in the PFA cycle. Wait at least 30 seconds in each PFA sound clip before pressing the direction button.  |



## Conventional DC

| <b>Start-up</b>   | <b>Solution</b>  |
|---|--|
| When I apply power to the track my engine doesn't do anything. No lights, no sound, no nothing. | Check to see if that section of track has power. Use a voltmeter or a lit passenger car.   |
|   | Slide the engine a couple of feet in either direction, you may have a bad track section  |
|   | Have you got that section electrically isolated with a toggle switch or other device?  |
| <b>Sound</b>  | <b>Solution</b>  |
| I have no sound from my engine, but my lights are on and it moves just fine.                    | Check the volume pot on your tender. Full CW = Max volume  |
| There's a crackling sound from my engine.   | Check to see if a screw or some other material hasn't lodged itself in the underside of the chassis or tender  |
|   | Make sure smoke volume pot is turned full CW   |
| <b>Smoke</b>  | <b>Solution</b>  |
| My engine isn't smoking at all.   | Make sure smoke volume pot is turned full CW   |
|   | If you just filled it with smoke fluid sometimes the fluid can make a seal in the stack. Blow down the stack to clear the air bubble   |
|   | Check the Tender/Boiler drawbar connection. You've got to have them locked together  |
| My engine's smoke output is low.  | If you've been running your engine in DCS or DCC mode the smoke may have gotten set to Low or Med. With the engine running in DCS or DCC set the smoke back to High. It'll remember what you last set it as when you run it again in Conventional DC |
|   | Check for an obstruction in the smoke stack  |
|   | Add 10-12 drops of smoke fluid   |

## Conventional DC

| <b>Lights</b>   | <b>Solution</b>   |
|---|---|
| One of my lights is out.  | Most likely you had been running the engine in DCC or DCS mode and toggled that light off. Put it back into one of those modes and turn that light back on. The engine will remember that when you run it again in Conventional DC. |
| None of my lights are on.   | Could be the same reason as "One of my lights is out"   |
|   | Is the engine getting power? Check to see if there is voltage on the track or move the engine a few feet in either direction.   |
| <b>Motion</b>   | <b>Solution</b>   |
| When I apply power to the track my engine starts up (lights and sound) but it won't move. | Lower the track voltage then raise it again. The engine should start moving. If you apply greater than 9VDC quickly the engine will just sit there. Lowering it below 9VDC then raising it will get the engine moving.              |
| My engine hesitates at slow speeds.   | An engine may do this right out of the box if it has not been lubricated. Follow the lubrication instructions. Now go ahead and run it.   |
|   | New engines even after they are lubricated may take a little bit to get everything run in. Be a little patient and let it run for a bit. It should clear up shortly after lubricating and running.                                  |

# DCC

| <b>Start-up</b>  | <b>Solution</b>   |
|--|---|
| When I apply power to the track my engine doesn't do anything. No lights, no sound.                            | Did you press F3 yet? F3 on your DCC handheld will start your engine up.  |
|  | Check to see if that section of track has power. Use a voltmeter or a lit passenger car, not your tongue.   |
|  | Slide the engine a couple of feet in either direction, you may have a bad track section.  |
|  | Have you got that section electrically isolated with a toggle switch or other device?   |
| <b>Sound</b>   | <b>Solution</b>   |
| I have no sound on my engine, but my lights are on and it moves just fine.                                     | You may have it turned off. Repeatedly press F6 to cycle through the volume levels (there are 9 levels, 0-max).   |
| There's a crackling sound from my engine.  | Check to see if a screw or some other material hasn't lodged itself in the underside of the engine.   |
| When I run Doppler I can hear the Doppler shift but then the engine sounds fade out and I can't get them back. | This is normal. You will need to press the F21 button again to turn Doppler off. Your engine sounds will now return to normal.  |
| <b>Smoke</b>   | <b>Solution</b>   |
| My engine isn't smoking at all.  | Make sure you've got the smoke switch ON. It must be ON for the smoke to operate in DCC Mode.   |
|  | Press F12 on your DCC handheld. This will activate the smoke.   |
|  | If you just filled it with the smoke fluid sometimes the fluid can make a seal in the stack blow down the stack to clear the air bubble.  |
| My engine barely smokes.   | You may have set the smoke to Low. F13 will vary the smoke levels. Or, if you were running it in DCS mode you may have toggled it there (if you don't have F13 on your DCC handheld you will have to put it back into DCS mode and change it from there), or follow the instructions to move the smoke volume into an F Function that exists on your controller |
|  | Check for an obstruction in the smoke stack   |
|  | Add 10-12 drops of smoke fluid  |

# DCC

| <b>Lights</b>  | <b>Solution</b>  |
|--|--|
| One of my lights is out.   | Check your F keys. F0 is the headlight (also controls the Back-up light) and F5 will toggle the Cab light and firebox light.   |
| None of my lights are on.  | Could be the same reason as “One of my lights is out”  |
|  | Is the engine getting power? Check to see if there is voltage on the track or move the engine a few feet in either direction.  |
| <b>Motion</b>  | <b>Solution</b>  |
| When I apply power and hit F3, my engine powers up but it won't move.                      | This is normal, dial up the speed on your DCC controller to make your engine move.   |
| My engine hesitates at slow speeds.  | An engine may do this right out of the box if it has not been lubricated. Follow the lubrication instructions. Now go ahead and run it.  |
|  | New engines even after they are lubricated may take a little bit to get everything run in. Be a little patient and let it run for a bit. It should clear up shortly after lubricating and running.                               |
| <b>PFA</b>   | <b>Solution</b>  |
| I hit F4 to start the PFA but the engine just keeps ringing its bell, that's all it'll do. | Bring the engine speed to 0. Now press F4. You will now hear the station arrival or freight yard sounds (pretty cool, huh?). Pressing F4 will cycle through the PFA sequences (check out the PFA section of the manual for more) |
| <b>Shut Down</b>   | <b>Solution</b>  |
| Okay, I give up. What do I have to do to shut it down?                                     | Well, you can either remove power from the track or press F3 again.  |
| <b>Lost or Unknown Address</b>   | <b>Solution</b>  |
| I can't call up my engine on the address I believe it to be set at.                        | Perform the 55-55-55 Reset instructions  |
|  | If you are trying to talk to an engine on its short address you may have set CV29 to activate long addressing. Try to get a hold of the engine on its last known long address  |
|  | Place the engine on the Programming Track output on your DCC system and write a value of 3 to CV1  |

## DCS (Remember, it's NOT DCC)

| <b>Start-up</b>  | <b>Solution</b>  |
|--|--|
| When I apply power to the track my engine doesn't do anything. No lights, no sound.                            | This is normal. You have to hit the Start-Up button.   |
|  | Check to see if that section of track has power. Use a voltmeter or a lit passenger car, not your tongue.  |
|  | Slide the engine a couple of feet in either direction, you may have a bad track section.   |
|  | Have you got that section electrically isolated with a toggle switch or other device?  |
| I get an error when I hit Start-Up.  | Have you recently changed the engine address?  |
|  | Check if there is power on that section of track the engine is sitting on (there has to be power for the signal to get to the engine and for the engine to be able to hear it).  |
| DCS is polarity sensitive when powered by a DC power supply.   | Check the polarity of the DC power supply connected to the Fixed 1 or Fixed 2 Inputs. Shut down power, reverse the inputs and repower DCS. Hitting the startup button on the DCS remote should start up the engine.                                      |
|  | If you have two engines on the track they both may have the same address. Take one of them off the rails and try it again.   |
| <b>Sound</b>   | <b>Solution</b>  |
| When I press the Whistle Button on my DCS remote or DCS commander the whistle doesn't blow.                    | Check if the playable whistle is active. On the DCS Commander there will be two dashes on the right side of the LCD if it's active. Press "A1" twice to ensure it's turned off. On your DCS remote press the "SPW" button twice to ensure it's disabled. |
| I have no sound on my engine, but my lights are on and it moves just fine.                                     | You may have it turned off. Repeatedly press VOL + to bring the Master Volume up.  |
|  | Did you turn off the ENG Sounds? Press the ENG SND button on your DCS controller.  |
|  | Check that you haven't lowered any of the independent engine volumes (Eng Sounds, Bell, Whistle, or Accent).   |
| There's a crackling sound from my engine.  | Check to see if a screw or some other material has lodged itself in the underside of the engine.   |
| When I run Doppler I can hear the Doppler shift but then the engine sounds fade out and I can't get them back. | This is normal. You will need to press the Doppler button again to turn Doppler off. Your engine sounds will now return to normal.   |

## DCS (Remember, it's NOT DCC)

| <b>Smoke</b>  | <b>Solution</b>  |
|---|--|
| My engine isn't smoking at all.   | Press the smoke button, this will activate the smoke   |
| My engine barely smokes.  | If you just filled it with the smoke fluid sometimes the fluid can make a seal in the stack. Blow down the stack to clear the air bubble.  |
|   | You may have set the smoke to Low. This can be changed from Low to Med to High.  |
|   | Check for an obstruction in the smoke stack  |
|   | Add 10-12 drops of smoke fluid   |
| <b>Lights</b>   | <b>Solution</b>  |
| One of my lights is out.  | Check that you haven't turned it off with the DCS controller. You have independent control over lights on your engine  |
| None of my lights are on.   | Could be the same reason as "One of my lights is out"  |
|   | Is the engine getting power? Check to see if there is voltage on the track or move the engine a few feet in either direction.  |
| <b>Motion</b>   | <b>Solution</b>  |
| When I apply power and hit Start-up, my engine powers up but it won't move. | This is normal, dial up the speed on your DCS Remote to make your engine move.   |
| My engine hesitates at slow speeds.   | An engine may do this right out of the box if it has not been lubricated. Follow the lubrication instructions. Now go ahead and run it.  |
|   | New engines even after they are lubricated may take a little bit to get everything run in. Be a little patient and let it run for a bit. It should clear up shortly after lubricating and running. |
| <b>PFA</b>  | <b>Solution</b>  |
| When I enter PFA all that happens is the bell rings. What do I do?          | Press the DIR button. Your engine will stop and begins the arrival sequence. Pressing the DIR button will cycle you through the next 3 PFA sequences   |
| Why does my engine run away all by itself after the PFA is over?            | This is normal. The engine will leave the station at the same speed it entered (when hit the PFA button). The speed setting can be changed after the bell stops ringing.                           |
| <b>Shut Down</b>  | <b>Solution</b>  |
| Okay, I give up. What do I have to do to shut it down?                      | Well, you can either remove power from the track or press or press Shut-Down. Button on the DCS Remote   |
| <b>Lost or Unknown Address</b>  | <b>Solution</b>  |
| I can't call up my engine on the address I believe it to be set at.         | Delete the engine from your DCS remote, and attempt to re-add it.  |
|   | On the DCS Remote, hit Menu > System > Engine Setup > Recover Engine   |

# Transformer Compatibility and Wiring Chart

Proto-Sound® 3.0 is designed to work with most standard AC transformers. The chart below lists the many compatible transformers. Note that many of the operational commands described in these instructions require a bell button, so if your transformer does not have its own bell button, you should consider adding one to get the full benefit of the system. In addition, the chart details how the terminals on these transformers should be attached to your layout.

| <b>RECOMMENDED AC TRANSFORMERS</b>    |                        |                       |                         |                     |                         |
|---------------------------------------|------------------------|-----------------------|-------------------------|---------------------|-------------------------|
| <b>Transformer Model</b>              | <b>Center Rail</b>     | <b>Outside Rail</b>   | <b>Min/Max. Voltage</b> | <b>Power Rating</b> | <b>Transformer Type</b> |
| MTH Z-500                             | Red Terminal           | Black Terminal        | 0-18v                   | 50-Watt             | Electronic              |
| MTH Z-750                             | Red Terminal           | Black Terminal        | 0-21v                   | 75-Watt             | Electronic              |
| MTH Z-1000                            | Red Terminal           | Black Terminal        | 0-21v                   | 100-Watt            | Electronic              |
| MTH Z-4000                            | Red Terminal           | Black Terminal        | 0-22v                   | 390-Watt            | Electronic              |
| Lionel 1032                           | U                      | A                     | 5-16v                   | 90-Watt             | Standard                |
| Lionel 1032M                          | U                      | A                     | 5-16v                   | 90-Watt             | Standard                |
| Lionel 1033                           | U                      | A                     | 5-16v                   | 90-Watt             | Standard                |
| Lionel 1043                           | U                      | A                     | 5-16v                   | 90-Watt             | Standard                |
| Lionel 1043M                          | U                      | A                     | 5-16v                   | 90-Watt             | Standard                |
| Lionel 1044                           | U                      | A                     | 5-16v                   | 90-Watt             | Standard                |
| Lionel 1053                           | U                      | A                     | 8-17v                   | 60-Watt             | Standard                |
| Lionel 1063                           | U                      | A                     | 8-17v                   | 60-Watt             | Standard                |
| Lionel LW                             | A                      | U                     | 8-18v                   | 75-Watt             | Standard                |
| Powermaster                           | U                      | A                     | 8-18v                   | 135VA               | Electronic              |
| All-Trol                              | Left Terminal          | Right Terminal        | 0-24v                   | 300-Watt            | Electronic              |
| Dallee Hostler                        | Left Terminal          | Right Terminal        |                         |                     | Electronic              |
| Lionel LW                             | A                      | U                     | 8-18v                   | 75-Watt             | Standard                |
| Lionel KW                             | A or B                 | U                     | 6-20v                   | 190-Watt            | Standard                |
| Lionel MW                             | Outside Track Terminal | Inside Track Terminal | 5-16v                   | 50V.A.              | Electronic              |
| Lionel RS-1                           | Red Terminal           | Black Terminal        | 0-18v                   | 50V.A.              | Electronic              |
| Lionel RW                             | U                      | A                     | 9-19v                   | 110-Watt            | Standard                |
| Lionel SW                             | U                      | A                     | Unknown                 | 130-Watt            | Standard                |
| Lionel TW                             | U                      | A                     | 8-18v                   | 175-Watt            | Standard                |
| Lionel ZW                             | A,B,C or D             | U                     | 8-20v                   | 275-Watt            | Standard                |
| Lionel Post-War Celebration Series ZW | A,B,C or D             | Common                | 0-20v                   | 135/190 Watt        | Electronic              |

# DC Power Supply Chart

| <b>RECOMMENDED DC TRANSFORMERS</b>                   |  |                     |   |                         |
|--|--|---------------------|---|-------------------------|
| <b>Transformer Model</b>                             | <b>Min/Max. Voltage</b>                | <b>Power Rating</b> | <b>Notes On Use</b>   | <b>Transformer Type</b> |
| MRC 6200   | 0-18.5v                                | 60-Watt             | Not Recommended For #70-3001-1 J3a  | Electronic              |
| MRC Controlmaster 20                                 | 0-20v                                  | 100-Watt            |   | Electronic              |
| PH Hobbies PS5                                       | 0-20v                                  | 100-Watt            |   | Electronic              |
| PH Hobbies PS10G                                     | 0-20v                                  | 180-Watt            |   | Electronic              |
| Bridgeworks Magnum 15                                | 0-24v *                                | 300-Watt            |   | Electronic              |
| Bridgeworks Magnum 200                               | 0-24v *                                | 300-Watt            |   | Electronic              |
| Bridgeworks Magnum 400                               | 0-24v *                                | 300-Watt            |   | Electronic              |
| Bridgeworks Magnum 1000                              | 0-24v *                                | 300-Watt            |   | Electronic              |
| LGB Jumbo #50101                                     | 0-24v *                                | 240-Watt            | Not recommended for #70-3001-1 J3a  | Electronic              |
| Crest CRE-55460 Power Supply w/ CRE-55401 Controller | 18VDC on Supply, 0-18VDC at Controller | 180-Watt            | FOR ANALOG DC OPERATION <b>ONLY</b><br>Controller has PWM Output from Fixed DC Input<br><b>DO NOT Use with the DCS System (TIU)</b><br>PWM Output from this power supply Will <b>DAMAGE</b> the TIU | Electronic              |

\* Use 22 volts maximum track voltage when operating a MTH locomotive equipped with Proto-Sound, Loco-Sound, Proto-Sound 2.0, or Proto-Sound 3.0



## Additional features accessible with the DCS Remote Control System

(Additional equipment required)

While conventional mode operation of a Proto-Sound® 3.0 engine yields wonderfully realistic sound and several train control features, command mode operation allows the user to access a world of command functions never before accessible to O Gauge railroaders. With the addition of the DCS Remote Control System (including a DCS remote handheld and Track Interface Unit) users gain many advanced features, including:

- **DCS Proto-Speed Control:** Establishes desired locomotive speed in scale miles per hour increments via a thumbwheel control and allows operator to set maximum speed and acceleration/deceleration rates
- **ProtoSmoke™ Variable Output Control:** Controls how much smoke each engine outputs and matches smoke to locomotive speed
- **Locomotive Lighting Control:** Controls locomotive headlights, marker and interior lights, beacon lights, ditch lights, and MARS lights
- **Emergency Stop:** Single button push stops all Proto-Sound® 2.0 and Proto-Sound® 3.0 engines but does not turn off the input power to the TIU
- **One Touch Global Mute/UnMute:** Single button mutes or unmutes all DCS-controlled locomotives' sounds
- **Proto-Dispatch Operation:** Public Address-like feature allows users to speak through locomotive speaker during operation
- **Proto-Cast:** Allows users to play audio recordings through locomotive speaker during operation
- **Proto-Doppler Sound Effects Set-Up:** Users can configure locomotive for Doppler Operation, including setting distance points for Doppler start, repeat, and stop modes
- **Independent Volume Control of Engine Sounds, Bell, Horn & Whistle, and Accent Sounds for each Locomotive**
- **Control up to 99 different DCS-Equipped Locomotives at one time with multiple TIUs**
- **Proto-Effects™ Set-Up:** User can select individual Proto-Effects™ operations to be active or inactive, including cab chatter, train wreck sounds, coupler sounds
- **Direction Control Set-Up:** User can set initial individual start-up direction (start in forward or reverse) for double-heading operations
- **Locomotive Consist Set-up:** User can determine locomotive values for consist make-ups, allowing multiple locomotives belonging to a consist to operate together

# Service & Warranty Information

## How to Get Service Under the Terms of the Limited One-Year Warranty

When you suspect an item is defective, please check the operator's manual for standard operation and troubleshooting techniques that may correct the problem. Additional information may be found on the M.T.H. Website. Should you still require service, follow the instructions below to obtain warranty service. First, e-mail, write, call or fax a M.T.H. Authorized Service Center (ASC) in your area to obtain Repair Authorization. You can find the list of ASCs on the M.T.H. Website, [www.mthtrains.com](http://www.mthtrains.com). Authorized Service Centers are required to make warranty repairs on items sold only from that store; all other repairs may-- or may not be done at the store's own discretion. If you did not purchase the item directly from the ASC, you will need to select a National Authorized Service Center (NASC). These centers are compensated by M.T.H. to perform warranty service for any customer whose repair qualifies for warranty service. A list of NASC retailers can be located on the M.T.H. Website or by calling 410-381-2580. Should the warranty no longer apply, you may choose either an ASC or NASC retailer to service your M.T.H. Product. A reasonable service fee will be charged.

**CAUTION:** Make sure the product is packed in its original factory packaging including its foam and plastic wrapping material to prevent damage to the merchandise. There is no need to return the entire set if only one of the components is in need of repair unless otherwise instructed by the Service Center. The shipment must be prepaid and we recommend that it be insured. A cover letter including your name, address, daytime phone number, e-mail address (if available), Return Authorization number (if required by the service center, a copy of your sales receipt and a full description of the problem must be included to facilitate the repairs. Please include the description regardless of whether you discussed the problem with a service technician when contacting the Service Center for your Return Authorization.

Please make sure you have followed the instructions carefully before returning any merchandise for service. Authorized M.T.H. Service Centers are independently owned and operated and are not agents or representatives of M.T.H. Electric Trains. M.T.H. assumes no responsibility, financial or otherwise, for material left in their possession, or work done, by privately owned M.T.H. Authorized Service Centers.

If you need assistance at any time email MTH Service at [service@mth-railking.com](mailto:service@mth-railking.com), or call 410 381-2580.

## Limited One-Year Warranty

All M.T.H. products purchased from an M.T.H. Authorized Retailer are covered by this warranty provided the product was manufactured within five years of the date of purchase. This warranty is for the original purchaser and is non-transferable.

See our website [www.mthtrains.com](http://www.mthtrains.com) to identify an M.T.H. Authorized Retailer near you.

M.T.H. products may be registered online in advance of warranty work at [www.mthtrains.com/warranty](http://www.mthtrains.com/warranty). The original sales receipt and the conditions below must be met regardless of whether the product is registered on the M.T.H. website in order to obtain warranty service.

M.T.H. products manufactured within five years from the date of purchase are warranted for one year against defects in material or workmanship, excluding wear items such as light bulbs, pick-up rollers, batteries, smoke unit wicks, and traction tires. We will repair, replace, or credit (at our option) the defective part without charge for the parts or labor if the following conditions are met: (1) the item is returned to an M.T.H. Authorized Service Center\* (ASC) or M.T.H. National Authorized Service Center (NASC) or M.T.H. Electric Trains Service Department, (2) was manufactured within the previous five years and (3) was purchased within one year of the original date of purchase from an M.T.H. Authorized Retailer. Products manufactured after the five year cutoff from the date of purchase are not covered under any warranty by M.T.H. Electric Trains. The manufacture date of an item can be verified on the item's detail page "shipping date field" on the M.T.H. website ([www.mthtrains.com](http://www.mthtrains.com)). This warranty does not cover damages caused by improper care, handling, or use. Transportation costs incurred by the customer are not covered under this warranty.

Items sent for repair must be accompanied by a return authorization number, a description of the problem, and a **copy of the original sales receipt from an M.T.H. Authorized Retailer**, which gives the date of purchase. If you are sending this product to an Authorized Service Center, contact that Center for their return authorization.

This warranty gives you specific legal rights, and you may have other rights that vary from state to state. Specific questions regarding the warranty may be forwarded to M.T.H. Directly.

\* Authorized Service Centers (ASC) are only obligated to provide warranty service for any consumer who has purchased the specific M.T.H. item from them that requires service work.

Service Department:  
M.T.H. Electric Trains  
7020 Columbia Gateway Drive  
Columbia MD 21046-1532