

RAIL KING
By M.T.H. Electric Trains

M.T.H.
ELECTRIC TRAINS®

7020 Columbia Gateway Drive
Columbia, MD 21046-1532

www.mth-railking.com

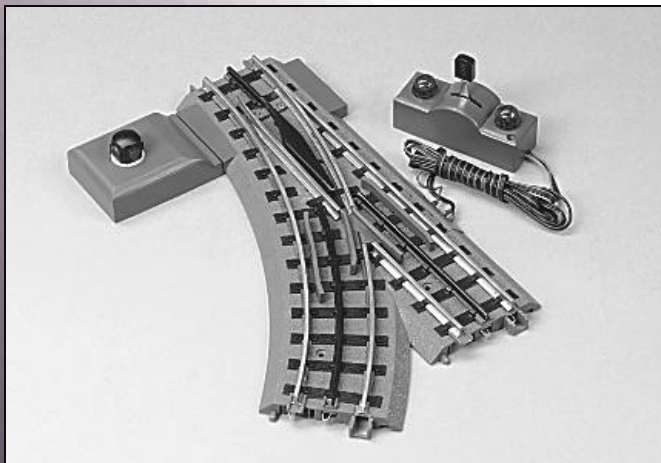

MTH RealTrax® switches add flexibility and reliability to your O Gauge RealTrax layout. Designed to provide years of trouble-free, smooth operation, RealTrax switches are the perfect additions to expand your RailKing® empire.

REAL TRAX®
BY M.T.H. ELECTRIC TRAINS

O S W I T C H

Table of Contents

Introduction:	3
Operating Caution	3
Switch Operating Instructions:	4
RealTrax® O-54 Switch Components:	4
Screw Terminal Definition:	6
Remote Switch Wiring Instructions:	7
Basic Switch Operation:	7
Changing Switch Block Positions:	8
Accessory Operation From Switch Power Out:	9
Multiple Connections Under Screw Terminal	9
Multiple Switch Operating Instructions (Track Power):	9
Multiple Switch Operation Through One Remote Switch, Track Power, Identical Throws:	9
Multiple Switch Operation Through One Remote Switch, Track Power, Opposite Throws:	10
Auxiliary Powered Switch Operating Instructions:	10
Multiple Switch Operation Through Separate Remote Switches	11
Multiple Switch Operation Through One Remote Switch, Auxiliary Power, Identical Throws	11
Multiple Switch Operation Through One Remote Switch, Auxiliary Power, Opposite Throws	12
RealTrax® O-54 Switches In Tubular Rail Layouts:	13
Multiple Train Operation Using Powered/Unpowered Sidings:	14
Troubleshooting	15
Service and Warranty Information	16
How to Get Service Under The Terms of The Limited One Year Warranty	16
Limited One Year Warranty	16

Introduction

Thank you for purchasing the MTH Electric Trains Real Trax O-54 Switch. As with all Real Trax products, you will find the O-54 Switch easy to install into your layout whether it be a permanent or temporary one. There are no plastic and/or metal pins to lose or confuse. The setup is simple; with only three connections of easy-to-attach connectors and the turn of a screw, your Real Trax Switch will be up and running in no time!

The Real Trax O-54 Switch performs all of the functions of other switches, but better. It has a double-microswitch driven non-derailing feature. Inside the Switch Block (lantern housing) are four powerful but efficient and quiet solenoid coils that drive the switch points back and forth at a voltage and current draw as yet unexperienced in model railroading. The Real Trax Switch operates on only 10 Volts and 1.25 Amps. It has a spring-assisted mechanism that ensures that the points always will be in the correct position. If you change directions with a Real Trax Switch, you will not have to worry about derailments or electrical short circuits.

The Real Trax Switch can be wired for operation via track power or auxiliary power. Also, you will be able to operate several Real Trax Switches together by following the appropriate illustrated diagram(s) in this manual. It can be installed into a layout to have powered and unpowered sidings for multiple train operation (see page 14).

The Real Trax O-54 Switch is constructed of sturdy ABS plastic, solid extruded rails and simple yet sturdy electronics. The design has been streamlined with features like a Switch Block Cover that hides the opening to the switch's underside and a Screw Terminal Cover that hides the traditionally unsightly yet necessary wire connections. The design follows other Real Trax items so that it blends into your layout, instead of standing out. With its ruggedness and slim styling, the Real Trax O-54 Switch will give you years of trouble-free operation on either your Real Trax or your tubular rail O-Gauge model railroad.

CAUTION-ELECTRICALLY OPERATED PRODUCT:

Not recommended for children under eight years of age without adult supervision. As with all electric products, precautions should be observed during handling and use to reduce the risk of electric shock.

WARNING: When using electrical products, basic safety precautions should be followed including the following:

- Read this manual thoroughly before using this device.
- MTH recommends parents examine the O-54 Switch periodically for condition that may result in the risk of fire, electric shock, or injury to persons, such as damaged wires, clips or other parts, and that, in an event such condition exist, the O-54 Switch should not be used until properly repaired.
- This O-54 Switch is intended to be used indoors. Do not use if water is present. Serious or fatal injury may result.
- Do not operate the O-54 Switch with damaged wires or clips.
- If damaged call MTH service for instructions.
- Do not use this O-54 Switch for other than its intended purpose. This unit was designed to operate with any AC or DC output of a train transformer. See the individual transformer's operating manual for more operating and safety information.

RealTrax® O-54 Switch Operating Instructions:

RealTrax O-54 Switch Components:

- 1) Switch:
Consistsoftheroadbed,rails,points,frog,screwterminals,operating circuitry andmechanisms.
- 2) ScrewTerminalCover:
Plastic coverthatattachestoheroadbedandconcealsthescrew terminals.
- 3) Jumper:
Removablemetalconnectorbetween 4thand5thscrewterminals. The Jumperactsasaswitchbetweentrackandauxiliarypower.
- 4) SwitchBlock:
Consistsofhousing,solenoidcoilsandlantern. TheSwitchBlock attachestoeitherrectangularportattheconvergingendoftheSwitch. TheSwitchBlockmaybeattachedtoeithersideoftheswitch.
- 5) SwitchBlockCover:
Plastic coverthatattachestoandconcealstheunusedSwitchBlock port.
- 6) RemoteSwitch:
Separatemanualswitchwithmomentaryaction. TheRemoteSwitch canoperateyour switchfromanywhereonyourlayout.

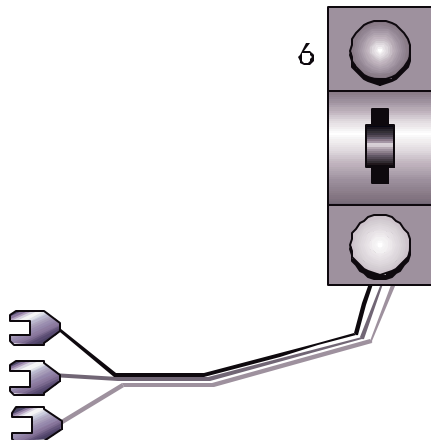

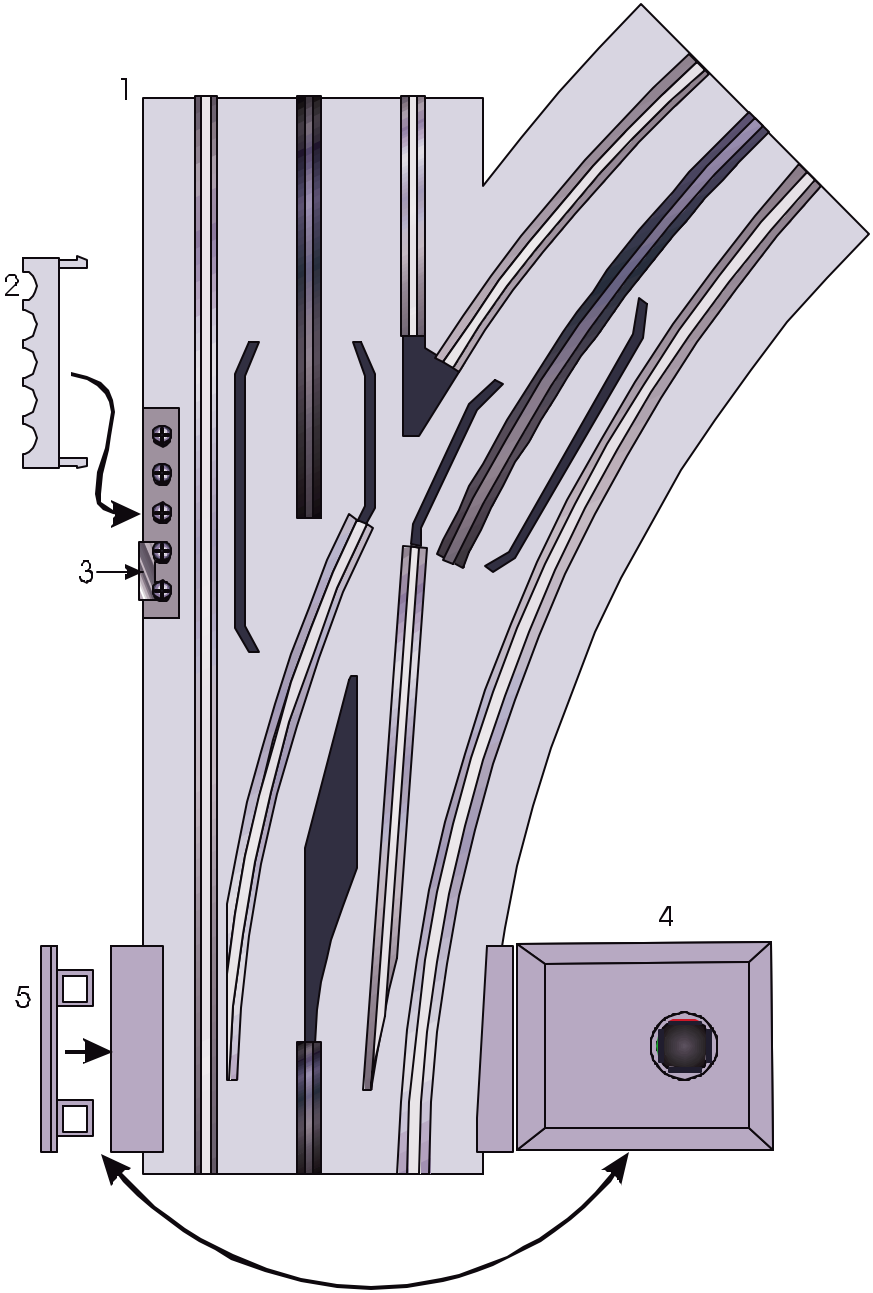

Screw Terminal Definition

There are five Screw Terminals located under the Screw Terminal Cover on the straight edge of every Real Trax Switch. The positions of the Screw Terminals on a Right-Hand Switch mirror those on the Left-Hand Switch.

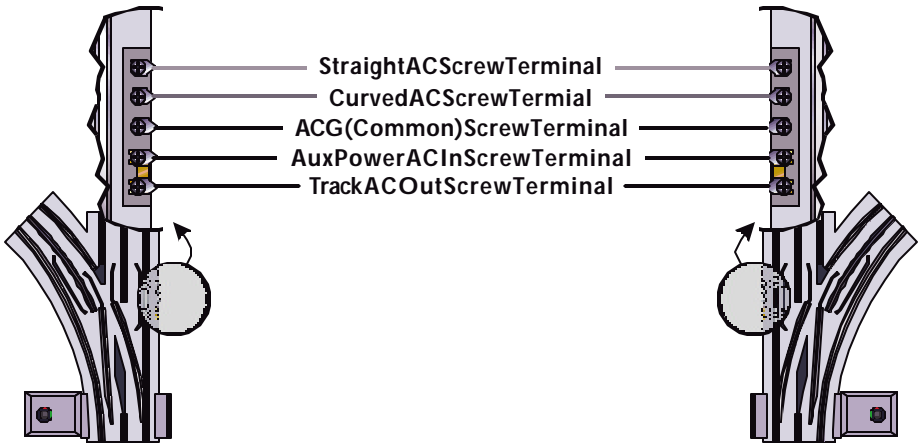

Straight AC Screw Terminal: This Screw Terminal is the input connection of AC power that causes the points (rail that shift positions) to align with the straight direction of travel. The Straight AC Screw Terminal may be connected to either the GREEN wire of the Remote Switch or an external AC power source.

Curved AC Screw Terminal: This Screw Terminal is the input connection of AC power that causes the points (rail that shift positions) to align with the curved direction of travel. The Curved AC Screw Terminal may be connected to either the RED wire of the Remote Switch or an external AC power source.

ACG (Common) Screw Terminal: This Screw Terminal is the electrical ground connection for all power and Remote Switch inputs.

Auxiliary Power AC In Screw Terminal: This Screw Terminal is the input connection of an outside power source's AC (powered) terminal. (Note: the jumper between the Auxiliary Power AC In Screw Terminal and the Track AC Out Screw Terminal must be removed to operate your switch via auxiliary power).

Track AC Out Screw Terminal: This Screw Terminal is connected directly to track power (center rail).

RemoteSwitch WiringInstruction

You will have to wire the RealTrax O-54 Remote Control Switch to the proper Screw Terminals.

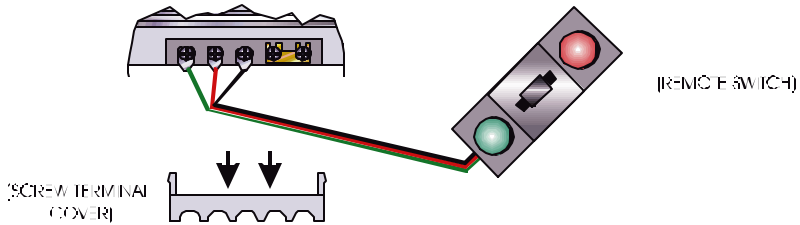

- Connect the GREEN wire of the REMOTE SWITCH to the Straight AC SCREW TERMINAL (found under the removable SCREW TERMINAL COVER).
- Connect the RED wire of the REMOTE SWITCH to the Curved AC SCREW TERMINAL.
- Connect the BLACK wire of the REMOTE SWITCH to the ACG (Common) SCREW TERMINAL.
- The JUMPER between the fourth and fifth SCREW TERMINALS remains in place.

Basic Switch Operation:

Now that your RealTrax Switch is wired, you will be able to operate it via any of the following methods:

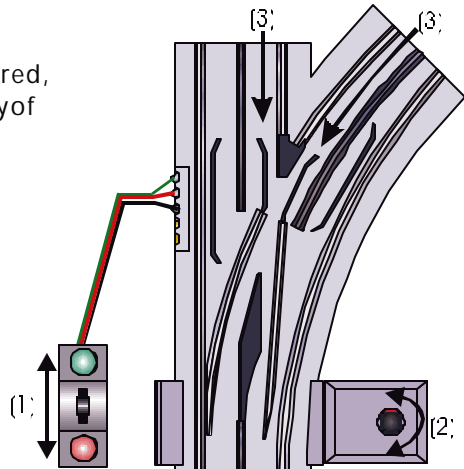

- Remote Switch operation (1). Push the remote switch lever toward the green light for 'straight' operation. Push the remote switch lever toward the red light for 'curved' operation.
- Manual (lantern) operation (2). Simply turn the lantern on the Switch Block to align the points in the desired direction.
- Automatic non-derail operation (3). If your consist enters the diverging end of the switch, the points will automatically align to the correct orientation (if necessary).

Changing SwitchBlockPosition:

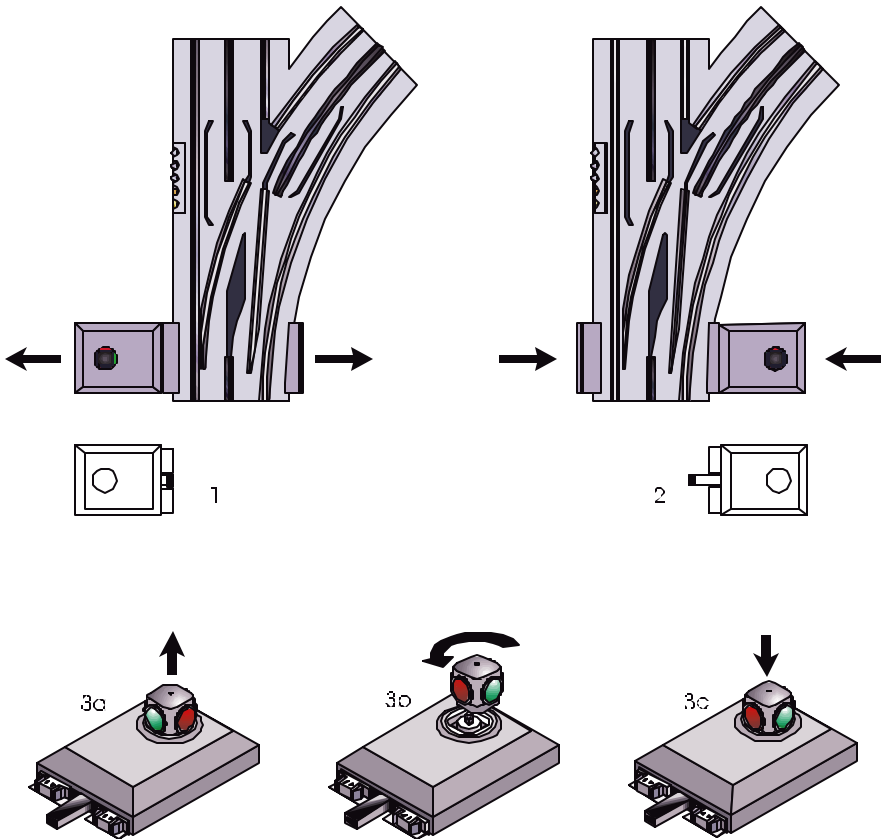

To change the position of the SwitchBlock, follow the steps below:

- 1) Remove the SwitchBlock by pulling it firmly out of the roadbed. Remove the SwitchBlock Cover by sliding it down out of the roadbed.
- 2) Install the SwitchBlock into the other side by pushing it firmly into the roadbed. Install the SwitchBlock Cover into the other side.
- 3) You will have to change the position of the SwitchBlock Lantern so that the Green lenses align to the straight direction and the red lenses align to the curved direction.
 - a) Hold the SwitchBlock Lantern between your thumb and forefinger. Gently pull the Lantern out of its socket.
 - b) Rotate the Lantern 90 Degrees (one-quarter turn).
 - c) Press the Lantern back into the SwitchBlock. You will hear a "snap" when it is in place.

Accessory Operation from Switch Track AC Out Screw Terminal:

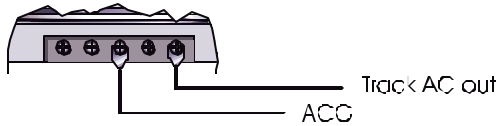

- Connect the ACG (Common) terminal of the accessory to the ACG (Common) screw terminal of the Switch.
- Connect the AC (Powered) terminal of the accessory to the Track AC Out screw terminal of the Switch.

Making Multiple Connections Under One Screw Terminal

If you do not use female disconnect type connectors to make your wire terminations for multiple connections, you are encouraged to reduce the number of wires under each Screw Terminal by stripping a section in the middle of a single wire:

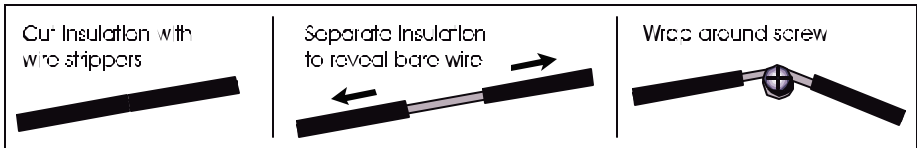

(Note: MTH recommends that 18 gauge or thicker wire be used in wiring the RealTrax switch.)

RealTrax® O-54 Switch Multiple Switch Operation

Multiple switch operation through one Remote Switch (track power, identical throws):

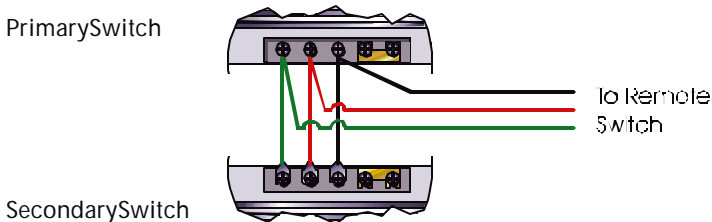

- Connect Remote Switch as shown on page 7.
- Connect the STRAIGHT AC screw terminal of the Primary Switch to the STRAIGHT AC screw terminal of the Secondary Switch.
- Connect the CURVED AC screw terminal of the Primary Switch to the CURVED AC screw terminal of the Secondary Switch.
- Connect the ACG (Common) screw terminal of the Primary Switch to the ACG (Common) screw terminal of the Secondary Switch.

Multiple switch operation through one Remote Switch (track power, simultaneous opposite throws):

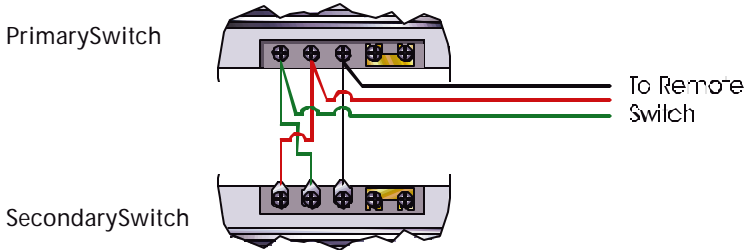

- Connect Remote Switch as shown on page 7.
- Connect the STRAIGHT AC screw terminal of the Primary Switch to the CURVED AC screw terminal of the Secondary Switch.
- Connect the CURVED AC screw terminal of the Primary Switch to the STRAIGHT AC screw terminal of the Secondary Switch.
- Connect the ACG (Common) screw terminal of the Primary Switch to the ACG (Common) screw terminal of the Secondary Switch.

Auxiliary Powered Switch Operating Instructions

The RealTrax Switch can be powered from an auxiliary power source (either another channel on your transformer or a separate transformer altogether). Powering your Switch from auxiliary power will ensure that varying track power does not affect the action of the switch. Also, if you operate at low voltages or wish to operate many switches at once, auxiliary power operation may be desirable.

Auxiliary power switch operation (to power switch from source other than track power):

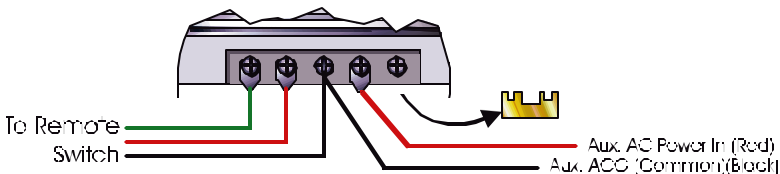

- Remove Jumper between Track AC Out terminal and Aux. Power AC In terminals (Save the jumper for future use).
- Connect Remote Switch as shown on page 7.
- Connect Auxiliary Power AC to Auxiliary Power AC In screw terminal
- Connect Auxiliary Power ACG (Common) to ACG (Common) screw terminal.

Auxiliary power operation of multiple switches through separate Remote Switches (separate throws):

Primary Switch

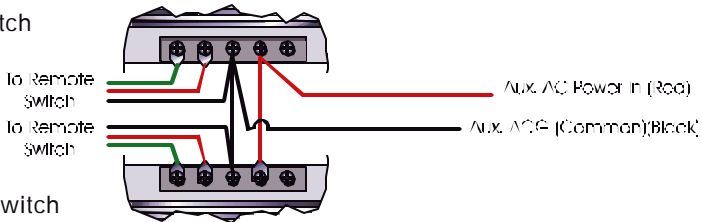

Secondary Switch

- Remove Jumpers from all auxiliary powered switches.
- Connect Remote Switches as shown on page 7.
- Connect Auxiliary Power ACG (Common) to all auxiliary powered switch ACG screw terminals, either in series (from one Switch ACG terminal to the next, as shown) or in parallel (each Switch ACG terminal is wired directly to the auxiliary power source).
- Connect Auxiliary Power AC to all auxiliary powered switch Aux. Power In AC screw terminals, either in series (from one Switch AC terminal to the next) or in parallel (each Switch AC terminal is wired directly to the auxiliary power source).

Auxiliary power operation of multiple switches through single Remote Switch (simultaneous identical throws):

Primary Switch

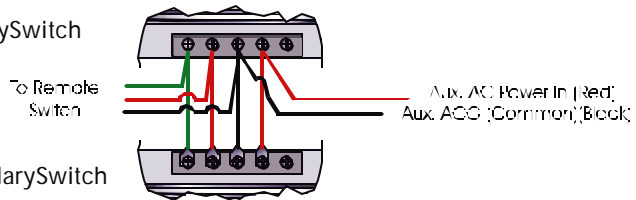

Secondary Switch

- Remove Jumpers from all auxiliary powered switches.
- Connect Remote Switch to primary switch as shown on page 7.
- Connect Auxiliary Power AC to Auxiliary Power AC In screw terminal of primary switch.
- Connect Auxiliary Power ACG (Common) to ACG (Common) screw terminal of primary switch.
- Connect the STRAIGHT AC screw terminal of the Primary Switch to the STRAIGHT AC screw terminal of the Secondary Switch.
- Connect the CURVED AC screw terminal of the Primary Switch to the CURVED AC screw terminal of the Secondary Switch.
- Connect the ACG (Common) screw terminal of the Primary Switch to the ACG (Common) screw terminal of the Secondary Switch.
- Connect Aux AC Power In screw terminal of the Primary Switch to the Aux AC Power In screw terminal of the secondary switch.

Auxiliary power operation of multiple switches through single Remote Switch (simultaneous opposite throws):

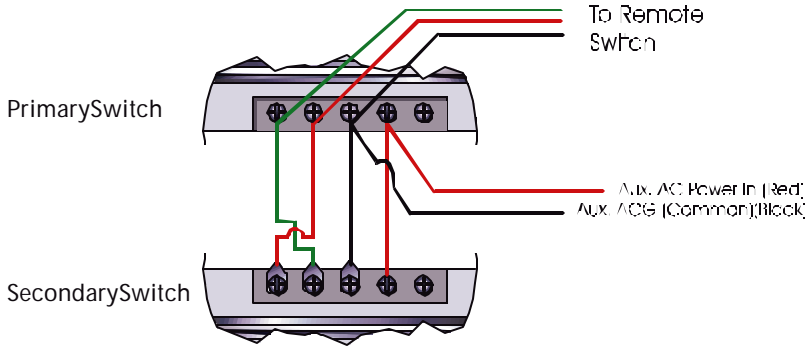

- Remove Jumpers from all auxiliary powered switches.
- Connect Remote Switch to primary switch as shown on page 7.
- Connect Auxiliary Power AC to Auxiliary Power AC In screw terminal of primary switch.
- Connect Auxiliary Power ACG (Common) to ACG (Common) screw terminal of primary switch.
- Connect the STRAIGHT AC screw terminal of the Primary Switch to the CURVED AC screw terminal of the Secondary Switch.
- Connect the CURVED AC screw terminal of the Primary Switch to the STRAIGHT AC screw terminal of the Secondary Switch.
- Connect the ACG (Common) screw terminal of the Primary Switch to the ACG (Common) screw terminal of the Secondary Switch.
- Connect Aux AC Power In screw terminal of the Primary Switch to the Aux AC Power In screw terminal of the secondary switch.

RealTrax® O-54 Switches In Tubular Rail Layouts:

The RealTrax O-54 Switch can be installed into O-Gauge tubular rail layouts with the use of three RealTrax Adapter Track Sections. Simply attach one Adapter Track Section (5" long) to each arm of the RealTrax O-54 Switch. The steel pins of your tubular track will insert into the tubular rail portion of the RealTrax Adapter Track.

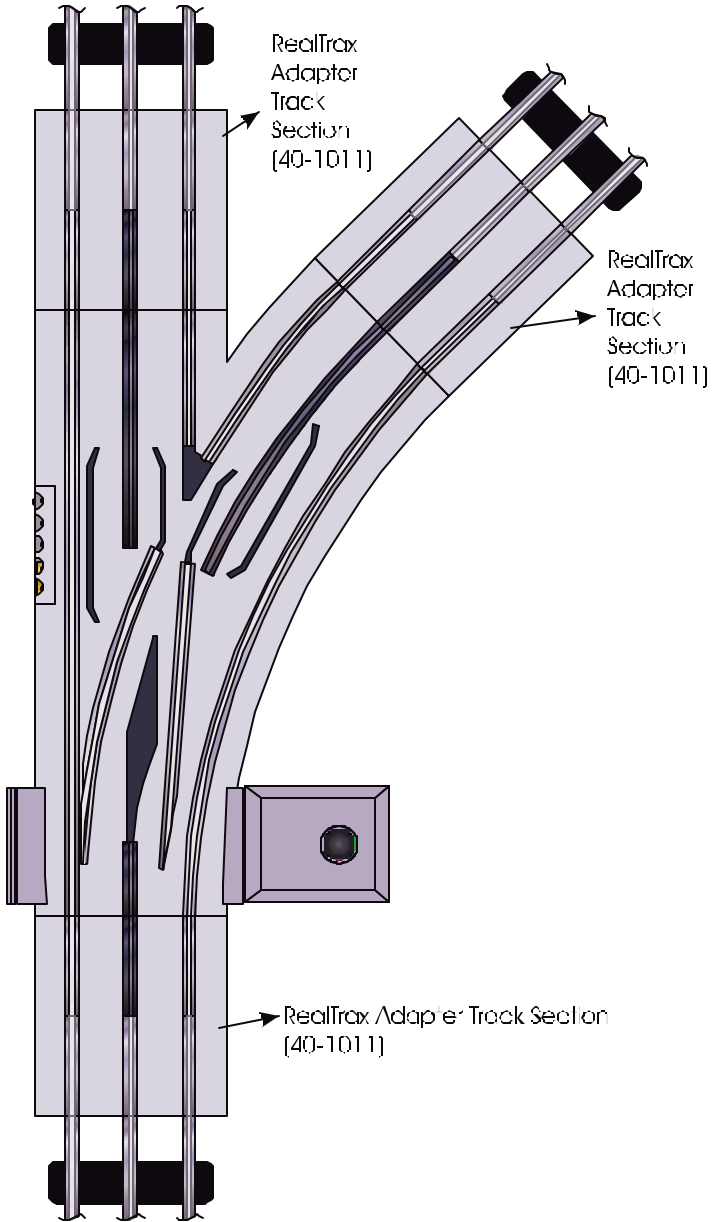

Multiple Train Operation (Powered/Unpowered Siding)

The following layout wiring diagram illustrates the use of two switches wired for simultaneous operation, identical throw. With this wiring arrangement, you will be able to operate two trains on your layout without collision (provided that no part of either consist obstructs the "Main Line" portion of the layout).

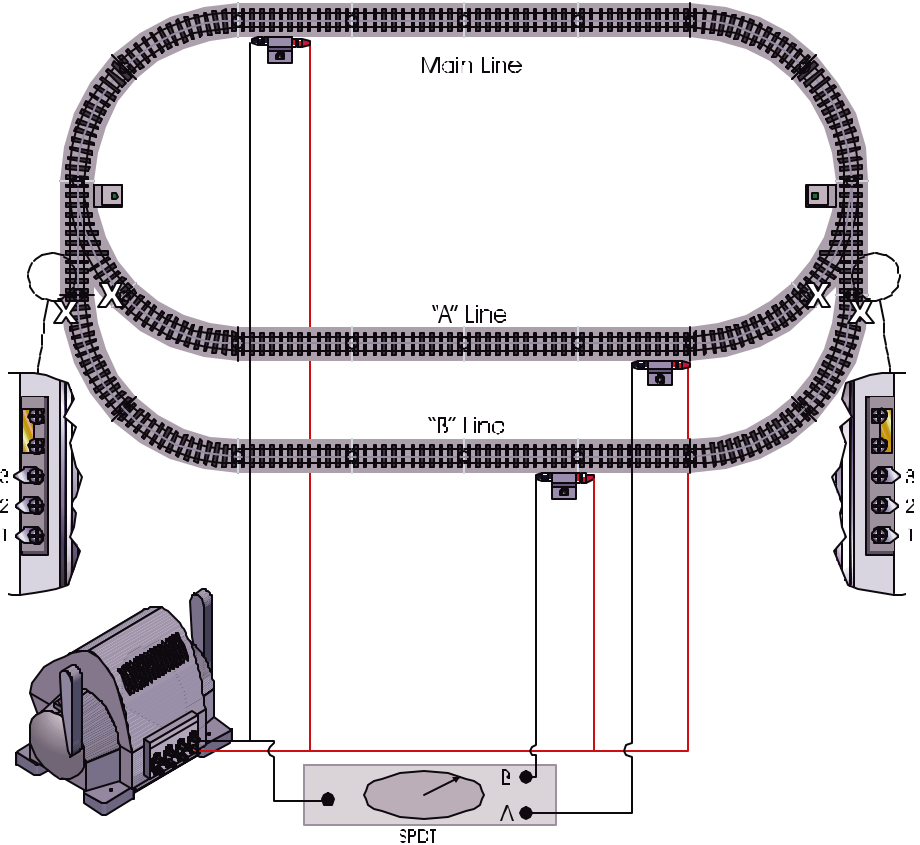

Layout Instructions:

Note: this layout requires a Single Pole, Double Throw switch (minimum 3A rating) available at a hardware or electrical store.

- 1) To assemble a Real Trax layout for Powered, Unpowered Siding Operation, you will have to isolate the outsiderail of the "A" Line and the outsiderail of the "B" Line. To do this, bend back and remove the brass connector under one end of the rail that is to be isolated (marked with "X" on the layout above).
- 2) Assemble the layout as shown.

Wiring Instructions:

- 1) Connect the Powered (Red) transformer output to the Powered (Red, center rail) terminals of the Main Line, "A" Line and "B" Line lock-ons.
- 2) Connect the Common (Black) transformer output to the Common (Black, outside rail) terminal of the Main Line lock-on.
- 3) Connect the Common (Black) transformer output to the input side of a Single-Pole, Double Throw (SPDT) switch (purchased separately).
- 4) Connect one output terminal of the SPDT switch to the Common (Black, outside rail) terminal of "A" Line. Connect the other output terminal of the SPDT switch to the Common (Black, outside rail) terminal of "B" Line.
- 5) Connect the Real Trax Switches as shown on page 9 for track power operation or as shown on page 10 for auxiliary power operation.

*Real Trax layout created with RR Track™ available from R&S Enterprises

Troubleshooting

Symptom	Remedy
Switch will not operate at all. Switch Block Lantern is not illuminated.	If using track power to operate the switch, check that the jumper between the Track AC Out Screw terminal and the Auxiliary AC Power In Screw Terminal is installed. If using Aux Power, check connection.
Switch will not operate. Switch Block Lantern is illuminated	If using auxiliary power to operate the switch, check that the jumper between the Track AC Out Screw Terminal and the Auxiliary AC Power In Screw Terminal is removed. If using track power, check connection.
Switch Points do not align completely into either the "straight" or "curved" position	Check that the operating voltage (track or auxiliary) is at least 10V. If operating your consist at < 10V, use auxiliary power for your switch(es).
Screw Terminal Cover will not fully attach to the roadbed-gap	Realign Remote Switch spade connectors to be perpendicular to the edge of the roadbed. If multiple wires under Screw Terminals, use female spade type connectors like those found on the ends of the Remote Switch wires.

How to Get Service Under the Terms of the Limited One-Year Warranty

For warranty repair, do not return your product to the place of purchase. Instead, follow the instructions below to obtain warranty service, as our dealer network is not prepared to service the product under the terms of this warranty.

1. First, write, call or FAX M. T. H. Electric Trains, 7020 Columbia Gateway Drive, Columbia, MD 21046, (Tel: 410-381-2580; FAX: 410-423-0009; e-mail: service@meth-railking.com), stating when it was purchased and what seems to be the problem. You will be given a return authorization number to assure that your merchandise will be properly handled upon its receipt.
2. **CAUTION:** Make sure the product is packed in its original factory packaging including its foam and plastic wrapping material so as to prevent damage to the merchandise. The shipment must be prepaid and we recommend that it be insured. ***A cover letter including your name, address, daytime phone number, e-mail address (if available), Return Authorization number, a copy of your sales receipt and a full description of the problem must be included to facilitate the repairs. Please include the description regardless of whether you discussed the problem with one of our service technicians when contacting M. T. H. for your Return Authorization number.***
3. Please make sure you have followed the instructions carefully before returning any merchandise for service.

Limited One-Year Warranty

All M. T. H. products purchased from an Authorized M. T. H. Train Merchant are covered by this warranty.

See our website at www.mth-railking.com or call 1-888-640-3700 to identify an Authorized M. T. H. Train Merchant near you.

M. T. H. products are warranted for one year from the date of purchase against defects in material or workmanship, excluding light bulbs and traction tires. We will repair or replace (at our option) the defective part without charge for the parts or labor, if the item is returned to M. T. H. Electric Trains within one year of the original date of purchase. This warranty does not cover damages caused by improper care, handling, or use. Transportation costs incurred by the customer are not covered under this warranty.

Items sent for repair must be accompanied by a return authorization number, a description of the problem, and the **original sales receipt from an Authorized M. T. H. Train Merchant**, which gives the date of purchase. Call 410-381-2580, fax 410-423-0009, or e-mail the Service Department at service@meth-railking.com to obtain a return authorization number.

This warranty gives you specific legal rights, and you may have other rights that vary from state to state.

Service Department
M. T. H. Electric Trains
7020 Columbia Gateway Drive
Columbia MD 21046-1532